



Rubinetteria

*Nicolazzi*

S.p.A.

**CATALOGO LISTINO PREZZI NOVITÀ**  
integrazione listino prezzi 2014

*Catalogue price list*  
*Catalogue tarif des prix*  
*Katalog und Preisliste*  
*Catálogo y lista de precios*  
*Catálogo y lista de preços*  
*Каталог прайс лист*

[www.nicolazzi.it](http://www.nicolazzi.it)

# Ecologico

CONSUMO D'ACQUA RIDOTTO DEL 50%  
WATER SAVING 50%

# Ecologico

PRODOTTO SENZA PIOMBO E NICHEL  
CON OTTONE IN LEGA ANTIDEZINCIFICANTE  
LEAD AND NICKEL FREE  
BRASS ALLOY WITHOUT ZINC

## La tradizione del Made in Italy di Alta Qualità nel rispetto della salute del consumatore e dell'ambiente *The tradition of High Quality Made in Italy in the environment and health respect*

L'acqua è un bene sempre più scarso e per questo sempre più prezioso. Più di un miliardo di persone nel mondo non hanno accesso all'acqua potabile ed almeno 500 milioni soffrono di grave carenza d'acqua. Non avere accesso all'acqua significa non avere a disposizione la quantità d'acqua minima giornaliera per le funzioni vitali. Il fabbisogno minimo biologico per la sopravvivenza è infatti di 5 litri in 24 ore, ma per parlare di condizioni accettabili c'è bisogno di un minimo giornaliero di circa 50 litri d'acqua pro capite. La crescita demografica della popolazione mondiale, l'aumento del consumo d'acqua nei paesi più ricchi e l'inquinamento delle risorse idriche stanno, infatti, creando uno squilibrio tra la disponibilità e la richiesta d'acqua potabile generando una vera e propria emergenza destinata ad accentuarsi nei prossimi anni.

Nicolazzi S.p.A., a riconferma della continua attenzione rivolta alla difesa dell'ambiente ed all'ecologia, ha introdotto su tutta la rubinetteria da lavabo e da lavello uno speciale sistema di risparmio idrico al fine di ridurre del 50% il consumo d'acqua giornaliero (portata limitata a max. 5,7 L/min.). L'utilizzo di uno speciale rompigetto ad elevata aerazione garantisce inoltre la qualità del flusso di erogazione in ogni condizione di pressione.

L'acqua è un elemento fondamentale per la vita del nostro pianeta, una risorsa che deve essere protetta e preservata. Nicolazzi S.p.A ci ha pensato, pensateci anche voi e richiedeteci i rubinetti con la riduzione di portata del 50% al fine di poter consumare anche voi solo l'acqua necessaria. Il risparmio d'acqua è un dovere civile nei confronti dei nostri simili, protegge l'ambiente (contribuisce anche alla riduzione delle emissioni di CO2) e permette anche di risparmiare denaro.

*Water is a more and more precious good because less and less available. More than a billion people in the world do not have access to drinkable water and 500 millions people have serious problems in getting water. Not having access to water means not having the minimum daily vital amount of water. Individual biological minimum need is 5 litres/24hours, but in order to have acceptable conditions we speak about 50 litres/24hours. World population increase, huge use of water in western Countries and pollution of available sources are causing a general water emergency, estimated to get worse in years to come.*

*Nicolazzi S.p.A., confirming once more its attention to environment, applied to all washbasins and sink mixers a "water saving system" in order to reduce by 50% the daily use of water (max 5,7 l/min.). Use of a special aerator with high air amount gives a good water flow with low pressure as well.*

*Water is a basic element for life on our planet, a resource to be protected and saved. Nicolazzi S.p.A. cares about it, you can do the same by requiring "50% water saving" taps in order to use only the water you need. "Water saving" is a positive attitude, it protects the environment (it helps reducing carbon dioxide emissions, CO2) and it helps you saving money.*

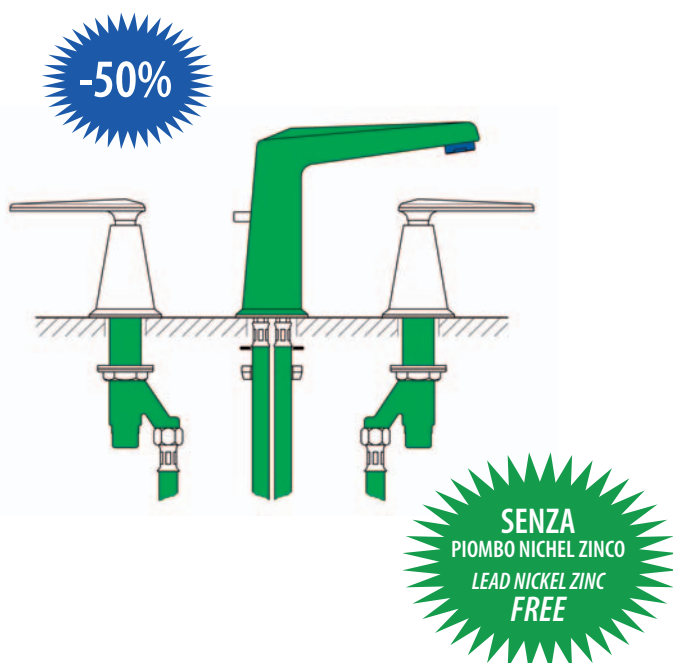

Nicolazzi S.p.A., da anni attenta ai problemi derivanti dal possibile rilascio di sostanze inquinanti e tossiche dei rubinetti, si è attivata per realizzare prodotti atossici soprattutto per quanto riguarda la cessione di metalli pesanti quali PIOMBO e NICHEL. La rubinetteria Nicolazzi S.p.A. sulla base di strette normative internazionali ha applicato all'intera produzione, che interessa la rubinetteria da cucina e da lavabo, un nuovo speciale ciclo produttivo che elimina la cessione di questi metalli pesanti già all'origine. A tale proposito, Nicolazzi S.p.A. si è attivata per sostituire il trattamento chimico da anni impiegato per la rimozione del PIOMBO dai rubinetti, con l'utilizzo di ottoni SENZA PIOMBO di nuova generazione (Pb max. 0.25%) nella propria produzione ecologica. Tale scelta, pur essendo antieconomica per l'azienda, risulta essere un'ulteriore riconferma della filosofia aziendale rivolta a garantire la salute del consumatore soddisfacendo al tempo stesso la legge americana Ab1953, che ad oggi risulta essere la più restrittiva in materia. Tutto questo, abbinato all'impiego di un sistema chimico che inibisce la cessione di NICHEL a contatto con l'acqua potabile ed all'utilizzo di guarnizioni e/o prodotti non metallici atossici, ha permesso a Nicolazzi S.p.A. di testare i propri rubinetti anche secondo la norma americana NSF-61, con una cessione in acqua potabile di PIOMBO inferiore a 11 ppb (µg/l) e di NICHEL inferiore a 20 ppb (µg/l).

N.B: Le limitazioni attualmente più rappresentative per la cessione di metalli da parte di articoli di rubinetteria nelle acque potabili limitano appunto la cessione del PIOMBO a 11 ppb (µg/l) e la cessione di NICHEL a 20 ppb (µg/l).

Oltre a certificare che tutti i rubinetti per cucina e lavabo subiscono questo speciale ciclo produttivo ANTI-PIOMBO e NICHEL, i pezzi sono prodotti con ottone in lega ADZ antidezincificante (assenza rilascio di ZINCO), nel rispetto della norma Australiana Watermark e trattati secondo le norme americane NSF-61.

Nicolazzi S.p.A., prima in Italia ad adottare questo procedimento, dimostra in questo modo un'alta sensibilità ai problemi connessi all'ambiente, all'ecologia ed alla salute del consumatore.

La riconoscibilità del prodotto è garantita dal marchio "Ecologico" su ciascun rubinetto.

*Nicolazzi S.p.A., very careful with issues concerning release of toxic materials from water taps, has been manufacturing for many years "health friendly" products, mainly not releasing heavy metals such as LEAD and NIKEL into drinking water.*

*Nicolazzi S.p.A., based on strict international rules, is using a special manufacturing system for all its sinks and washbasin taps to avoid release of heavy metals. To this regard, Nicolazzi S.p.A. has now started a re-organizing process to replace previous "LEAD washing" chemical treatment with the use of new generation LEAD-FREE brass (maximum LEAD 0.25%). This costly Company policy confirms the philosophy to grant consumers' health in respect of the new American norm Ab1953, actually the strictest one in our business. All this, with the chemical treatment to avoid release of NIKEL in drinking water and the use of non-toxic washers and components, allowed Nicolazzi S.p.A. to obtain American norm NSF-61, with a LEAD release less than 11 ppb (µg/l) and NIKEL less than 20 ppb (µg/l).*

*NOTE: Actually the strictest limitation for heavy metals release in drinking water for taps are LEAD less than 11 ppb (µg/l) and NIKEL less than 20 ppb (µg/l).*

*Beside above procedures against LEAD and NIKEL, our items are made with a special DZR brass (alloy with no release of ZINC) for the Australian Watermark regulation and produced following the NSF-61 American rules.*

*Nicolazzi S.p.A., the first Italian Company with this manufacturing process, shows a strong sensibility to problems regarding environment, ecology and consumers' health.*

*Our commitment is granted by the "ECOLOGICO" logo on each tap.*

Esempi di Cessione di Nichel e Piombo da rubinetti Nicolazzi prodotti con il processo "ECOLOGICO" e rubinetti non trattati.

Examples of session of nickel and lead from Nicolazzi's taps made with "ECOLOGICO" process, and taps not treated.

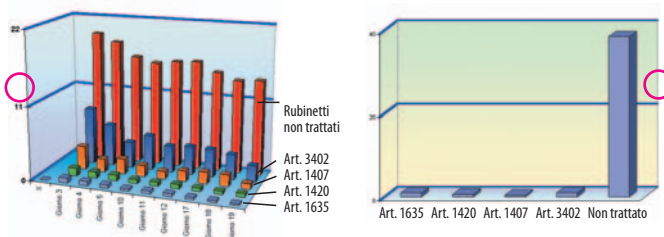

Limite massimo accettabile 11 ppb di piombo.  
*The acceptable maximum limit is 11 ppb of lead.*

Limite massimo accettabile 20 ppb di nichel.  
*The acceptable maximum limit is 20 ppb of nickel.*

rubinetteria  
**NICOLAZZI**



Dal 1960, anno della sua fondazione, la NICOLAZZI S.p.A. ha la sede in Alzo (No), piccolo paese sul lago d'Orta famoso in tutto il mondo per la lavorazione del granito prima (fino agli anni '50) e dei rubinetti oggi.

La Rubinetteria NICOLAZZI si è innestata in questa tradizione operando ad alto livello tecnologico che, insieme alla ricerca stilistica e funzionale, permette la realizzazione di una rubinetteria di qualità superiore.

La ditta NICOLAZZI studia e progetta i suoi prodotti in modo autonomo ed originale nel rispetto delle normative internazionali. Sottopone ogni pezzo ad un serio e minuzioso collaudo controllando tenuta, rumorosità, durata, funzionalità ed accurate finiture.

Questo modo di produrre ha permesso di adottare il sistema di qualità ISO 9000. La certificazione è un'ulteriore garanzia della qualità del prodotto che esce dal proprio stabilimento per raggiungere i clienti più esigenti alla ricerca di prodotti qualificati. Una efficiente rete commerciale assicura una distribuzione dei nostri prodotti sia in Italia che nel mondo.

*"From 1960, the year of this establishment, the NICOLAZZI S.p.A. is placed in Alzo (No) a small village on the lake of Orta, famous all over the world for the granite-working until the Fifties and nowadays for the production of taps."*

*The NICOLAZZI tap manufacturer has married this tradition working with an high technical standard, that, together with stylistic and functional research, allows the realisation of superior quality taps.*

*The company NICOLAZZI studies and designs its own items in an original and individual way, by respecting the International Norms. Each piece is subject to a very serious and particular inspection by testing water-seal, noise, corrosion, functionality and careful finishings.*

*This way of production allowed to adopt the quality system ISO 9000. The certification is a further guarantee of the quality of our items, that leave the factory to reach the most exigent clients that are looking for qualified products.*

*A very efficient commercial organisation assure the distribution of our articles in Italy and in the world."*



certificazione prodotti  
products certification

USA - CANADA \*



USA \*

**LOW-LEAD**

California  
Lead Plumbing Law  
AB 1953

USA \*

**GREEN**



AUSTRALIA and  
NEW ZEALAND \*



AUSTRALIA and  
NEW ZEALAND \*



BELGIUM \*



BELGAQUA

RUSSIA \*



\* For selected items only

certificazione  
certification



SISTEMA QUALITA'  
CERTIFICATO UNI  
EN ISO 9001:2008

Certificato n° 0316



## tabella finiture finishings table

- CR** CROMO / *CHROME*
- NL** NICHEL LUCIDO / *BRIGHT NICKEL*
- OG** OTTONE GREZZO / *RAW BRASS*  
Ottone naturale soggetto ad ossidazione / *Living natural brass*
- OL** OTTONE LUCIDO / *SHINING BRASS*  
Ottone naturale soggetto ad ossidazione / *Living natural brass*
- OS** OTTONE SPAZZOLATO / *BRUSHED BRASS*  
Ottone naturale soggetto ad ossidazione / *Living natural brass*
- GO** ORO / *GOLD*
- RG** ORO ROSA / *ROSE GOLD*

## finiture speciali special finishings

- AG** ANTIQUE GOLD / *ANTIQUE GOLD*
- BZ** BRONZATO / *BRONZE PLATED*
- CB** CROMO SPAZZOLATO / *BRUSHED CHROME*
- CO** CROMO ORO / *CHROME GOLD*
- CS** CROMO SATINATO / *SATIN CHROME*
- FV** FERRO VECCHIO / *IRON*
- GB** GOLD BRASS / *GOLD BRASS*
- GF** ORO INGLESE / *ENGLISH GOLD*
- NS** NICHEL SATINATO / *SATIN NICKEL*
- RA** RAMATO / *COPPER PLATED*
- TB** TUSCAN BRASS / *TUSCAN BRASS*  
Ottone naturale soggetto ad ossidazione / *Living natural brass*
- CL** COLORATO / *COLOURED*
- DB** BRONZO SCURO / *DARK BRONZE*
- DBM** BRONZO SCURO OPACO / *DARK BRONZE MATT*

### ISTRUZIONI PER LA PULIZIA CLEANING INSTRUCTIONS

La pulizia di tutti i nostri prodotti deve essere eseguita esclusivamente utilizzando acqua, sapone neutro ed un panno morbido (NON abrasivo) al fine di preservarne la finitura nel tempo. Tutti i prodotti devono sempre essere asciugati con un panno morbido (NON abrasivo) al fine di impedire la formazione di depositi di calcare. Per quanto riguarda la finitura TB suggeriamo l'utilizzo della nostra speciale cera (articolo C9996) al fine di mantenere nel tempo il tipico colore "marrone". Le finiture non sono coperte da garanzia in quanto subordinate alla cura dell'utente.

*Concerning cleaning of our products we suggest you to use always water, neutral soap and a soft cloth. This will allow you to preserve finishings for a long time. For TB we have a special wax (item C9996) to maintain longer its typical «brown» colour. Finishings are not covered by warranty.*

## guida alla composizione del codice di acquisto instructions to compose the purchase code

La composizione del codice d'acquisto deve essere eseguita nel seguente modo:  
*The composition of the purchase code must be effected in the following way:*

**esempio / for example**

Art. **2002 CR 38**

- Tipo di maniglia / Type of handle
- Sigla finitura / Finishing abbreviaton
- Codice articolo / Code article

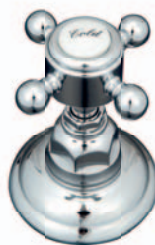

**CR**

Classica finitura galvanica di cromo lucido realizzata a spessore al fine di garantire lunga durata. L'elevata durezza superficiale tipica del cromo conferisce ai prodotti elevate doti di resistenza.

*Standard chrome finishing worked in «thick layer» to give long durability and strong resistance.*



**FV**

Finitura galvanica di tonalità scura, sottoposta a lavorazione manuale di "spazzolatura" e protetta da vernice trasparente opaca.

*Dark galvanic finishing, hand brushed and protected with a matt transparent paint. Good for modern and antique styles.*



**GF**

Finitura galvanica di doratura realizzata a spessore con i medesimi materiali impiegati per il gold brass però con concentrazione ridotta al fine di fornire un oro di tonalità ancora più chiara tipica dei paesi anglosassoni.

*Galvanic gold colour. Second shade of gold colour.*



**AG**

Finitura galvanica con tonalità simile all'oro antico, sottoposta a lavorazione manuale di "spazzolatura" e protetta da vernice trasparente opaca. Indicata per le serie classiche.

*Galvanic gold colour, hand brushed and protected with a matt transparent paint. Indicated for classic style.*



**TB**

Finitura di esclusiva Nicolazzi che conferisce un vero look antico ai prodotti tramite ossidazione dell'ottone. **IMPORTANTE:** questa è una finitura "viva" (non protetta) che cambia nel tempo offrendo variazioni di colore tipiche dell'ossidazione dell'ottone in abbinamento al tipico colore giallo del metallo che riemerge nelle zone di maggior contatto durante l'uso (maniglie, canne, etc.). **NON PULIRE CON PRODOTTI AGGRESSIVI.**

*Exclusive finishing from Nicolazzi. Real antique look. Galvanic oxidation of brass. IMPORTANT to know it is a «Living Finishing», it changes in time. A brass colour will come out. DO NOT CLEAN WITH AGGRESSIVE PRODUCTS.*

**Ottone naturale soggetto ad ossidazione  
Living natural brass**



**CL**

Classica finitura colorata (nera o bianca) ottenuta tramite verniciatura polimerica e successivamente cotta al forno per garantirne la più alta resistenza.

*Classic coloured (black or white) finish obtained by «polymer coating» and then baked in the oven to ensure the highest resistance.*



Finitura con le medesime caratteristiche del cromo con l'aggiunta della lavorazione manuale di "spazzolatura". Ottima sia per le serie moderne che per le serie classiche.

*Like CR but hand brushed. Good for modern and antique styles.*

CB



Finitura con medesime caratteristiche del cromo realizzata su superficie satinata anziché lucida. Normalmente viene utilizzata nelle serie moderne ed è eccellente, vista la sua resistenza, per la linea cucina.

*Chrome finishing on a «rough» surface. Normally used on modern styles and excellent for kitchen faucets for its strength.*

CS



Tipica finitura galvanica di nichel lucido. Eccellente per le serie classiche. **IMPORTANTE:** Nicolazzi offre questa finitura allo stesso prezzo del cromo. Rivestimento di base per la finitura oro, pur essendo realizzata a spessore, mantiene le caratteristiche tipiche del metallo nichel (morbidezza e predisposizione a lievi variazioni di tono nel tempo).

*Typical galvanic polished nickel finishing. Excellent for antique style. IMPORTANT is Nicolazzi offers it at same price than Chrome. First shade of gold colour.*

NL



Finitura con le medesime caratteristiche del Nichel con l'aggiunta della lavorazione manuale di "spazzolatura". Normalmente chiamata "color acciaio" è eccellente sia per le serie moderne che per le serie classiche.

*Just like Nickel but hand brushed. Normally called «STEEL colour». Excellent for modern and classic styles.*

NS

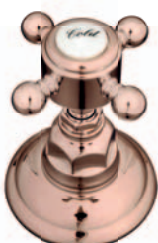

Rivestimento di vero oro 24k a spessore, ottenuto tramite processo galvanico che utilizza il sale industriale  $KAu(CN)_2$  estratto direttamente dal metallo prezioso, con l'aggiunta di un additivo per ottenere una colorazione rosa.

*Real 24k gold, obtained with the use in galvanic basin of an industrial salt  $KAu(CN)_2$  extracted from Genuine Gold Metal with the addition of a «special additive» to obtain the pink colour.*

RG



Rivestimento di vero oro 24k a spessore, ottenuto tramite processo galvanico che utilizza il sale industriale  $KAu(CN)_2$  estratto direttamente dal metallo prezioso.

*Real 24k gold, obtained with the use in galvanic basin of an industrial salt  $KAu(CN)_2$  extracted from Genuine Gold Metal. Darkest shade of gold colour.*

GO



Finitura galvanica di doratura realizzata a spessore con i medesimi materiali impiegati per l'oro però con concentrazione ridotta al fine di fornire un oro di tonalità più chiara.

*Galvanic gold colour. Third shade of gold colour.*

GB



Tipica finitura rame eseguita galvanicamente, sottoposta a lavorazione manuale di "spazzolatura" e protetta da vernice trasparente lucida.

*Typical Copper galvanic finishing, hand brushed and covered with a brilliant transparent paint.*

RA



Finitura di esclusiva Nicolazzi che conferisce un vero look antico ai prodotti. **IMPORTANTE:** questa è una finitura "viva" (non protetta) in quanto trattasi di ottone grezzo naturale non protetto che cambia nel tempo offrendo tonalità scure tipiche della passivazione del metallo.

*Exclusive finishing from Nicolazzi. Real antique look. IMPORTANT to know it is a «Living Finishing» that changes in time. It is raw not protected brass, it will soon be darker.*

**Ottone naturale soggetto ad ossidazione**  
*Living natural brass*

OG



Finitura tipica dell'ottone sottoposto a lavorazione di lucidatura brillante. **IMPORTANTE:** questa è una finitura "viva" (non protetta) in quanto trattasi di ottone lucido naturale non protetto che cambia nel tempo offrendo tonalità scure tipiche della passivazione del metallo.

*Polished brass NOT protected. IMPORTANT to know it is a «Living Finishing» that changes in time. It is not protected brass, it will soon be darker.*

**Ottone naturale soggetto ad ossidazione**  
*Living natural brass*

OL



Finitura ottenuta con la lavorazione manuale di "spazzolatura" sull'ottone naturale, **IMPORTANTE:** questa è una finitura "viva" (non protetta) in quanto trattasi di ottone grezzo naturale non protetto che cambia nel tempo offrendo tonalità scure tipiche della passivazione del metallo.

*Raw brass hand brushed. IMPORTANT to know it is a «Living Finishing» that changes in time. It is not protected brass, it will soon be darker.*

**Ottone naturale soggetto ad ossidazione**  
*Living natural brass*

OS



Tipica finitura galvanica di bronzatura, sottoposta a lavorazione manuale di "spazzolatura" e protetta da vernice trasparente lucida.

*Typical Bronze galvanic finishing, hand brushed and covered with a brilliant transparent paint.*

BZ



Tipica finitura galvanica di bronzatura in versione scura, sottoposta a lavorazione manuale di «spazzolatura» e protetta da vernice trasparente lucida.

*Typical Bronze galvanic finishing in dark version, hand brushed and covered with a brilliant transparent paint.*

DB



Tipica finitura galvanica di bronzatura in versione scura, sottoposta a lavorazione manuale di «spazzolatura» e protetta da vernice trasparente opaca.

*Typical Bronze galvanic finishing in dark version, hand brushed and covered with a matte paint.*

DBM

# index indice

## ■ EXTRA LUSO

LIBERTY ..... Pag. 7

## ■ TRADIZIONALE

ARENA ..... Pag. 15

AGORÀ ..... Pag. 23

## ■ MONOCOMANDI

TORRE ..... Pag. 33

ARENA ..... Pag. 37

## ■ PROGRAMMA CUCINA

KITCHEN PULL-DOWN ..... Pag. 44

KITCHEN ..... Pag. 45

## ■ TERMOSTATICO ..... Pag. 47

## ■ ACCESSORI BAGNO

LIBERTY ..... Pag. 55

ARENA ..... Pag. 63

AGORÀ ..... Pag. 71

MONTE CROCE ..... Pag. 77

## ■ ARTICOLI VARI - COMPLEMENTI ..... Pag. 85

■ LIBERTY



NL - Nichel Lucido / Bright Nickel

**Ecologico**  
PRODOTTO SENZA PIOMBO E NICKEL  
CON OTTONE IN LEGA ANTIDIZINCIFICANTE  
LEAD AND NICKEL FREE  
BRASS ALLOY WITHOUT ZINC

*Nicolazzi*







## LIBERTY



# Liberty



**1002** Gruppo vasca con doccia esterno duplex  
Bath tub set with duplex shower



**1008** Batteria lavabo scarico automatico  
Wash basin mixer with automatic pop-up waste



**1077** Batteria lavabo a parete  
Wash basin wall mounted

## LIBERTY

Con vitone ceramico / With ceramic cartridge / Avec cartouche ceramique / Mit oberteil aus keramik / Con cabeza ceramica / Com cabeça ceramica

## Art. 1002

Gruppo vasca con doccia esterno duplex

Bathtub set with duplex shower  
Mélangeur bain avec douche duplex  
Aufputz-Badewannengruppe mit duplex Handbrause

Mezclador exterior para baño-ducha  
Misturadora de banheira c/flexível  
Двухвентильный настенный с душем duplex для ванны

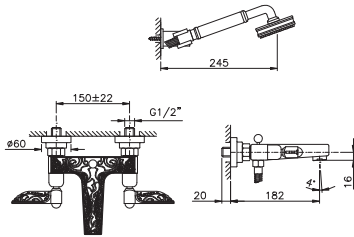

Optional Art. 5573 pag. 91

## Finitura / Finishing

16

CR NL OG OL OS 682,00

FINITURE SPECIALI \*  
SPECIAL FINISHING 921,00

GO RG 1.085,00

## Art. 1003

Gruppo vasca incasso erogazione a parete

Bathtub set wall mtg. central "sail" spout  
Mélangeur bain à encastrer  
Unterputz-Badewannengruppe mit Wandauslauf

Mezclador empotrado erogación de pared  
Grupo de banheira de encastrear  
Двухвентильный встраиваемый для ванны с изливом из стены

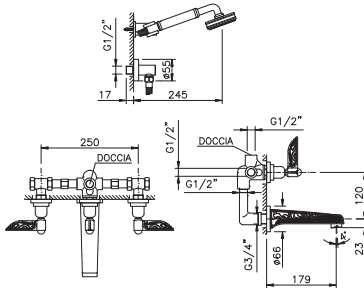

## Finitura / Finishing

16

CR NL OG OL OS 806,00

FINITURE SPECIALI \*  
SPECIAL FINISHING 1.088,00

GO RG 1.282,00

## Art. 1004

Gruppo bordo vasca 4 fori

Bathtub mixer on edge type with 4 holes  
Mélangeur bain sur le bord avec 4 trous  
Gruppe für 4-Loch Badewannenrand

Mezclador de repisa para baño-ducha  
Grupo lateral de banheira de 4 furos  
Двухвентильный на 4 отверстия на борт ванны

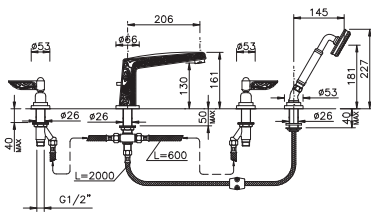

## Finitura / Finishing

16

CR NL OG OL OS 1.010,00

FINITURE SPECIALI \*  
SPECIAL FINISHING 1.363,00

GO RG 1.606,00

## Art. 1077

Batteria lavabo a parete

Wash basin wall mounted  
Mélangeur lavabo mural  
Washbecken am Wand

Lavabo de pared  
Lavatorio ligação a parede  
Двухвентильный настенный для раковины

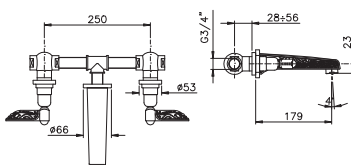

## Finitura / Finishing

16

CR NL OG OL OS 618,00

FINITURE SPECIALI \*  
SPECIAL FINISHING 835,00

GO RG 983,00

## LIBERTY

Con vitone ceramico / With ceramic cartridge / Avec cartouche ceramice / Mit oberteil aus keramik / Con cabeza ceramica / Com cabeça ceramica

## Art. 1008

Batteria lavabo scarico automatico

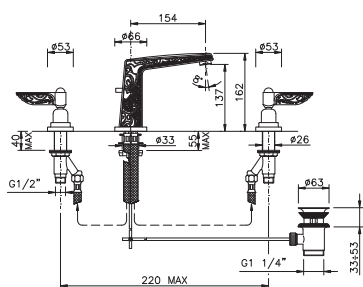

Wash basin mixer with automatic pop-up waste  
Mélangeur pour lavabo avec vidage automatique  
Waschbeckenbatterie mit automatischem Ablauf

Bateria lavabo desagüe automático  
Grupo lavatorio c/v.d.a.  
Двухвентильный на 3 отв.с для раковины

Finitura / Finishing

16

CR NL OG OL OS 618,00

FINITURE SPECIALI \*  
SPECIAL FINISHING 835,00

GO RG 979,00

## Art. 1010

Combinazione bidet

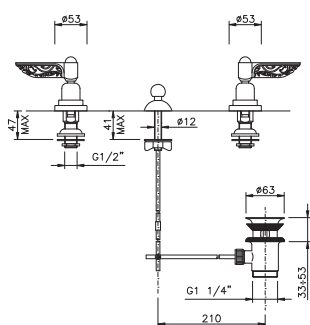

Bidet mixer with automatic pop-up waste  
Mélangeur pour bidet avec vidage automatique  
Kombination Bidet mit automatischem Ablauf

Combinación bidé desagüe automático  
Combinação bidet c/v.d.a.  
Двухвентильный на 3 отверстия для биде

Finitura / Finishing

16

CR NL OG OL OS 449,00

FINITURE SPECIALI \*  
SPECIAL FINISHING 606,00

GO RG 713,00

## Art. 1012

Rubinetto d'arresto

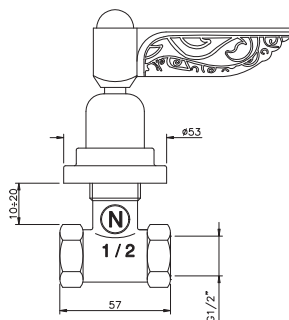

Built-in stop cock 1/2"  
Robinet arrêt 1/2"  
Unterputz-Sperventil 1/2"ü

Válvula de cierre empotrado 1/2"  
Passador de encastrar 1/2"  
Вентиль запорный 1/2"

Finitura / Finishing

16

CR NL OG OL OS 186,00

FINITURE SPECIALI \*  
SPECIAL FINISHING 251,00

GO RG 296,00

## Art. 1025

Gruppo doccia esterno (senza flex e doccia)

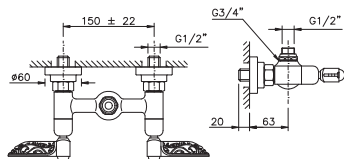

Shower mixer external type, without duplex  
Mélangeur douche extérieure, sans duplex  
Aufputz-Duschengruppe ohne flexibler und Dusche

Grupo ducha externo sin flexible y ducha  
Misturadora base chuveiro  
Двухвентильный для душа (без гибкого шланга и лейки)

Finitura / Finishing

16

CR NL OG OL OS 443,00

FINITURE SPECIALI \*  
SPECIAL FINISHING 599,00

GO RG 705,00



## LIBERTY

Con vitone ceramico / With ceramic cartridge / Avec cartouche ceramique / Mit oberteil aus keramik / Con cabeza ceramica / Com cabeça ceramica

## Art. 1047

Rubinetto lavatrice 3/4" con attacco flex 1/2"

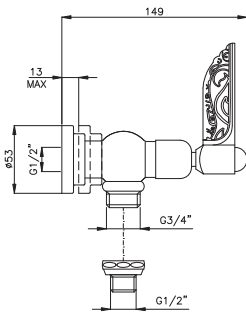

Single tap with washing machine connection 3/4"  
 Robinet avec raccordement pour machine à laver 3/4"  
 Waschmaschinenarmatur 3/4"

Grifo para lavadora 3/4"  
 Torneria de esquadria  
 Вентиль запорный для стиральной машины

## Finitura / Finishing

16

CR NL OG OL OS	209,00
FINITURE SPECIALI * SPECIAL FINISHING	282,00
GO RG	330,00

## Complemento doccia LIBERTY

## C7114

Doccia Liberty

Liberty hand shower  
 Douchette Liberty  
 Handbrause Liberty

Ducha Liberty  
 Chuveiro Liberty  
 Лейка Liberty



## Finitura / Finishing

CR NL OG OL OS	150,00
FINITURE SPECIALI * SPECIAL FINISHING	210,00
GO RG	285,00

# serie tradizionali

traditional series

---

■ ARENA



---

■ AGORÀ



*Nicolazzi*

ARENA



CL - Bianco Opaco / Matt White

**Ecologico**  
PRODOTTO SENZA PIOMBO E NICKEL  
CON OTTONE IN LEGA ANTIDIZINCIFICANTE  
LEAD AND NICKEL FREE  
BRASS ALLOY WITHOUT ZINC

*Nicolazzi*



05 - Ottone Spazzolato / *Brushed Brass*





## ARENA



CL - Nero Opaco / *Matt Black*

# Arena



**3302** Gruppo vasca esterno con doccia duplex  
Bath tub set with duplex shower



**3303** Gruppo vasca incasso erogazione a parete  
Bath tub set, wall mtg. central "sail" spout



**3325** Gruppo doccia esterno (senza flex e doccia)  
Shower mixer external type, without duplex



**3307** Batteria lavabo a parete  
Wash basin wall mounted



**3308** Batteria lavabo scarico automatico  
Wash basin mixer with automatic pop-up waste



**3318** Batteria lavabo scarico automatico  
Wash basin mixer with automatic pop-up waste



**3328** Batteria lavabo scarico automatico  
Wash basin mixer with automatic pop-up waste



**3310** Combinazione bidet  
Bidet mixer with automatic pop-up waste



**3315** Batteria per bidet esterna  
Outer group for bidet



**3312** Rubinetto d'arresto incasso 1/2"  
Built-in stop cock 1/2"



**3336** Monoforo lavabo scarico automatico  
Basin single-hole mixer with automatic pop-up waste



**3337** Monoforo bidet scarico automatico  
Bidet single-hole mixer with automatic pop-up waste



**3314** Gruppo bordo vasca 5 fori  
Bath tub mixer on edge type with 5 holes



**3324** Gruppo bordo vasca 5 fori  
Bath tub mixer on edge type with 5 holes



**\*\*44 Arena**

## ARENA

Con vitone ceramico / With ceramic cartridge / Avec cartouche ceramique / Mit oberteil aus keramik / Con cabeza ceramica / Com cabeça ceramica

## Art. 3302

Gruppo vasca esterno con doccia duplex

Bathtub set with duplex shower  
Mélangeur bain avec douche duplex  
Aufputs-Badewannengruppe mit duplex Handbrause

Mezclador exterior para baño-ducha  
Misturadora de banheira c/flexivel  
Двухвентильный с душем duplex для ванны

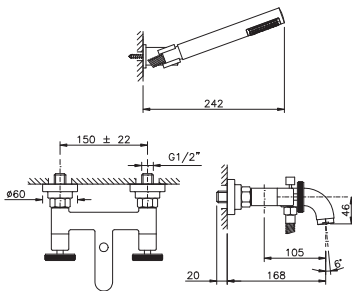

Finitura / Finishing

44

CR NL OG OL OS 367,00

FINITURE SPECIALI \*  
SPECIAL FINISHING 592,00

GO RG 804,00

Optional Art. 5573 pag. 91

## Art. 3303

Gruppo vasca incasso erogazione a parete

Bathtub set, wall mtg. central "sail" spout  
Mélangeur bain à encastrer  
Unterputz-Badewannengruppe mit Wanduslauf

Grupo bañera empotrado erogación de pared  
Grupo de banheira de ancastrar  
Двухвентильный встраиваемый для ванны с изливом из стены

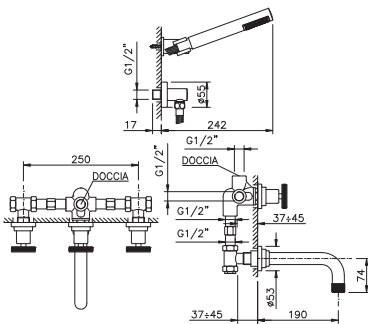

Finitura / Finishing

44

CR NL OG OL OS 541,00

FINITURE SPECIALI \*  
SPECIAL FINISHING 764,00

GO RG 1.074,00

## Art. 3325

Gruppo doccia esterno (senza flex e doccia)

Shower mixer external type, without duplex  
Mélangeur douche extérieure, sans duplex  
Aufputz-Duschengruppe ohne flexibler und Dusche

Grupo ducha externo sin flexible y ducha  
Misturadora base chuveiro  
Двухвентильный для душа (без гибкого шланга и лейки)

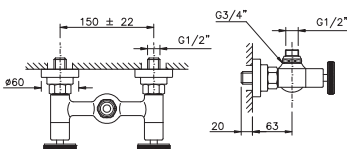

Finitura / Finishing

44

CR NL OG OL OS 175,00

FINITURE SPECIALI \*  
SPECIAL FINISHING 217,00

GO RG 297,00

## ARENA

Con vitone ceramico / With ceramic cartridge / Avec cartouche ceramice / Mit oberteil aus keramik / Con cabeza ceramica / Com cabeça ceramica

## Art. 3307

## Batteria lavabo a parete

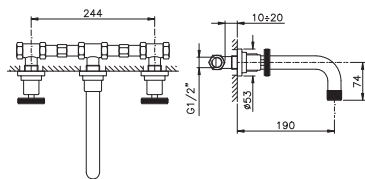
Wash basin wall mounted  
Mélangeur lavabo mural  
Waschbecken am WandLavabo de pared  
Lavatorio ligação a parede  
Двухвентильный настенный для раковины

## Finitura / Finishing

44

CR NL OG OL OS 270,00

FINITURE SPECIALI \*  
SPECIAL FINISHING 461,00

GO RG 631,00

## Art. 3308

## Batteria lavabo scarico automatico

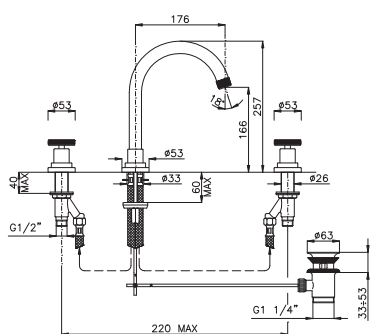
Wash basin mixer with automatic pop-up waste  
Mélangeur pour lavabo avec vidage automatique  
Waschbeckenbatterie mit automatischem AblaufMezclador lavabo con caño central  
Grupo lavatorio c/v.d.a.  
Двухвентильный на 3 отв. с функцией слива для раковины

## Finitura / Finishing

44

CR NL OG OL OS 327,00

FINITURE SPECIALI \*  
SPECIAL FINISHING 461,00

GO RG 631,00

## Art. 3318

## Batteria lavabo scarico automatico

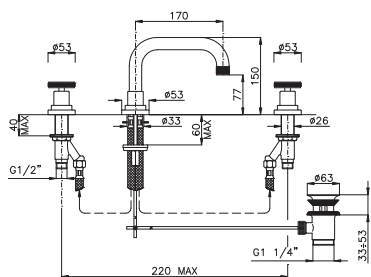
Wash basin mixer with automatic pop-up waste  
Mélangeur pour lavabo avec vidage automatique  
Waschbeckenbatterie mit automatischem AblaufMezclador lavabo con caño central  
Grupo lavatorio c/v.d.a.  
Двухвентильный на 3 отв. с функцией слива для раковины

## Finitura / Finishing

44

CR NL OG OL OS 327,00

FINITURE SPECIALI \*  
SPECIAL FINISHING 461,00

GO RG 631,00

## Art. 3328

## Batteria lavabo scarico automatico

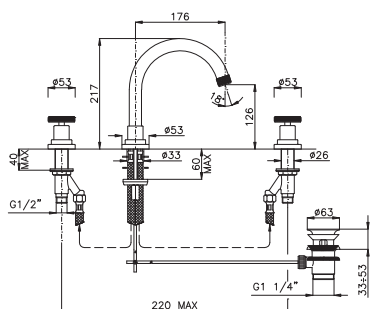
Wash basin mixer with automatic pop-up waste  
Mélangeur pour lavabo avec vidage automatique  
Waschbeckenbatterie mit automatischem AblaufMezclador lavabo con caño central  
Grupo lavatorio c/v.d.a.  
Двухвентильный на 3 отв. с функцией слива для раковины

## Finitura / Finishing

44

CR NL OG OL OS 327,00

FINITURE SPECIALI \*  
SPECIAL FINISHING 461,00

GO RG 631,00



## ARENA

Con vitone ceramico / With ceramic cartridge / Avec cartouche ceramique / Mit oberteil aus keramik / Con cabeza ceramica / Com cabeça ceramica

## Art. 3310

## Combinazione bidet

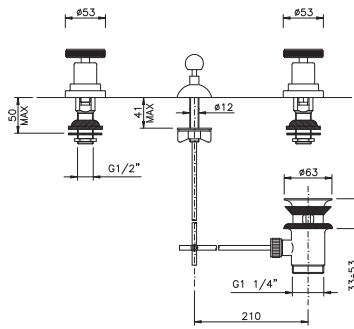

Bidet mixer with automatic pop-up waste  
Mélangeur pour bidet avec vidage automatique  
Kombination Bidet mit automatischem Ablauf

Combinacão bidé desagüe automático  
Combinacão bidet c/v.d.a.  
Двухвентильный с автоматическим сливом для биде

## Finitura / Finishing

44

CR NL OG OL OS 184,00

FINITURE SPECIALI \*  
SPECIAL FINISHING 336,00

GO RG 461,00

## Art. 3315

## Batteria per bidet esterna

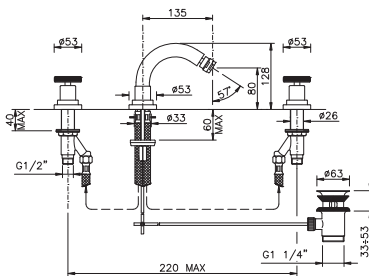

Outer group for bidet  
Groupe extérieur pour bidet  
Außengruppe für Bidet

Mezclador bidé con caõ central  
Grupo exterior para bidé  
Двухвентильный с автоматическим сливом для биде

## Finitura / Finishing

44

CR NL OG OL OS 319,00

FINITURE SPECIALI \*  
SPECIAL FINISHING 461,00

GO RG 631,00

## Art. 3311

## Batteria bidet con doccetta

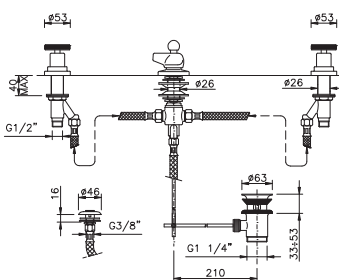

Bidet set with shower  
Mélangeur de bidet avec douche  
Bidetbatterie mit Handbrause

Combinacão bidé con churro ducha  
Combinacão bidet c/repuxo  
Двухвентильный с душиком на 3 отверстия для биде

## Finitura / Finishing

44

CR NL OG OL OS 368,00

FINITURE SPECIALI \*  
SPECIAL FINISHING 530,00

GO RG 719,00

## Art. 3312

## Rubinetto d'arresto incasso 1/2"

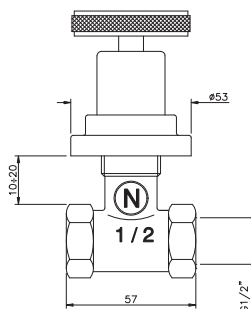

Built-in stop cock 1/2"  
Robinet arrêt 1/2"  
Unterputz-Sperventil 1/2"

Válvula de cierre empotrada 1/2"  
Passador de encastrar 1/2"  
Вентиль запорный 1/2"

## Finitura / Finishing

44

CR NL OG OL OS 93,00

FINITURE SPECIALI \*  
SPECIAL FINISHING 122,00

GO RG 162,00

## ARENA

Con vitone ceramico / With ceramic cartridge / Avec cartouche ceramice / Mit oberteil aus keramik / Con cabeza ceramica / Com cabeça ceramica

Art. **3336**

Monoforo lavabo scarico automatico

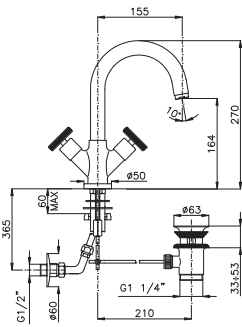

Basin single-hole mixer with automatic pop-up waste  
Mélangeur lavabo monotrou avec vidage automatique  
Einloch-Waschbecken mit automatischem Ablauf

Monohueco lavabo con desagüe automático  
Monofuro lavatorio c/v.d.a.  
Двухвентильный с автоматическим сливом для раковины

Finitura / Finishing

**44**CR NL OG OL OS **312,00**FINITURE SPECIALI \*  
SPECIAL FINISHING **423,00**GO RG **626,00**Art. **3337**

Monoforo bidet scarico automatico

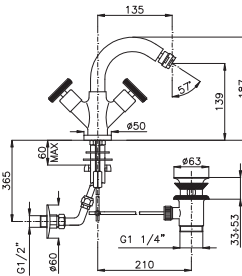

Bidet single-hole mixer with automatic pop-up waste  
Mélangeur bidet monotrou avec vidage automatique  
Einloch-Bidet mit automatischem Ablauf

Monohueco lbidé con desagüe automático  
Monofuro bidet c/v.d.a.  
Двухвентильный с автоматическим сливом для биде

Finitura / Finishing

**44**CR NL OG OL OS **297,00**FINITURE SPECIALI \*  
SPECIAL FINISHING **406,00**GO RG **615,00**Art. **3314**

Gruppo bordo vasca 5 fori

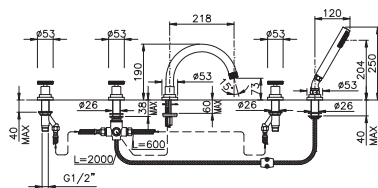

Bathtub mixer on edge type with 5 holes  
Mélangeur bain sur le bord avec 5 trous  
Gruppe für 5-Loch Badewannenrand

Mezclador de repisa para baño-ducha  
Grupo lateral de banheira de 5 furos  
Двухвентильный на 5 отверстий на борт ванны

Finitura / Finishing

**44**CR NL OG OL OS **630,00**FINITURE SPECIALI \*  
SPECIAL FINISHING **861,00**GO RG **1.224,00**Art. **3324**

Gruppo bordo vasca 5 fori

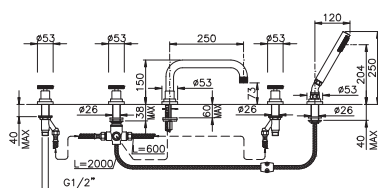

Bathtub mixer on edge type with 5 holes  
Mélangeur bain sur le bord avec 5 trous  
Gruppe für 5-Loch Badewannenrand

Mezclador de repisa para baño-ducha  
Grupo lateral de banheira de 5 furos  
Двухвентильный на 5 отверстий на борт ванны

Finitura / Finishing

**44**CR NL OG OL OS **630,00**FINITURE SPECIALI \*  
SPECIAL FINISHING **861,00**GO RG **1.224,00**

■ AGORÀ



05 - Ottone Spazzolato / *Brushed Brass*





# AGORÀ



**RG** - Oro Rosa / Rose Gold



# Agorà



**2302** Gruppo vasca esterno con doccia duplex  
Bathub set with duplex shower



**2325** Gruppo doccia esterno (senza flex e doccia)  
Shower mixer external type, without duplex



**2308** Batteria lavabo scarico automatico  
Wash basin mixer with automatic pop-up waste



**2310** Combinazione bidet  
Bidet mixer with automatic pop-up waste



**2312** Rubinetto d'arresto incasso 1/2"  
Built-in stop cock 1/2"



**2336** Monoforo lavabo scarico automatico  
Basin single-hole mixer with automatic pop-up waste



**2337** Monoforo bidet scarico automatico  
Bidet single-hole mixer with automatic pop-up waste



**\*\* 45IN**



**\*\*05IN**



**\*\*18IN**

## Art. 2302

Gruppo vasca esterno con doccia duplex

Bathtub set with duplex shower  
Mélangeur bain avec douche duplex  
Aufputs-Badewannengruppe mit duplex Handbrause

Mezclador exterior para baño-ducha  
Misturadora de banheira c/flexivel  
Двухвентильный с душем duplex для ванны

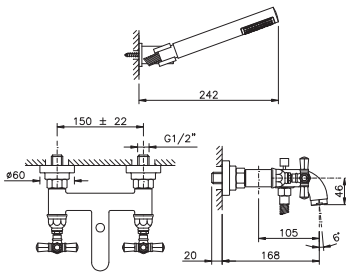

Optional Art. 5573 pag. 91

Finitura / Finishing	45IN	05IN	18IN
CR NL OG OL OS	441,00	355,00	319,00
FINITURE SPECIALI * SPECIAL FINISHING	637,00	551,00	515,00
GO RG	821,00	735,00	699,00

## Art. 2303

Gruppo vasca incasso erogazione a parete

Bathtub set, wall mtg. central "sail" spout  
Mélangeur bain à encastrer  
Unterputz-Badewannengruppe mit Wanduslauf

Grupo bañera empotrado erogación de pared  
Grupo de banheira de ancastrar  
Двухвентильный встраиваемый для ванны с изливом из стены

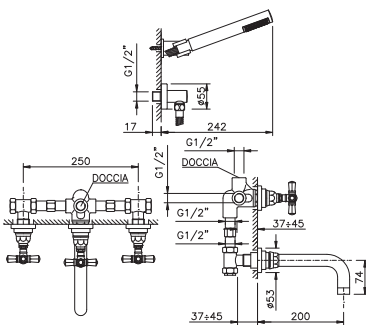

Finitura / Finishing	45IN	05IN	18IN
CR NL OG OL OS	653,00	524,00	470,00
FINITURE SPECIALI * SPECIAL FINISHING	847,00	718,00	664,00
GO RG	1.117,00	988,00	934,00

## Art. 2325

Gruppo doccia esterno (senza flex e doccia)

Shower mixer external type, without duplex  
Mélangeur douche extérieure, sans duplex  
Aufputz-Duschengruppe ohne flexibler und Dusche

Grupo ducha externo sin flexible y ducha  
Misturadora base chuveiro  
Двухвентильный для душа (без гибкого шланга и лейки)

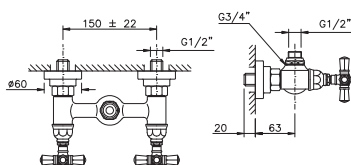

Finitura / Finishing	45IN	05IN	18IN
CR NL OG OL OS	274,00	188,00	152,00
FINITURE SPECIALI * SPECIAL FINISHING	311,00	225,00	189,00
GO RG	380,00	294,00	258,00

## AGORÀ

Con vitone ceramico / With ceramic cartridge / Avec cartouche ceramice / Mit oberteil aus keramik / Con cabeza ceramica / Com cabeça ceramica

## Art. 2307

## Batteria lavabo a parete

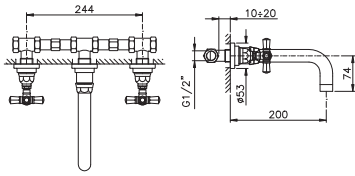
Wash basin wall mounted  
Mélangeur lavabo mural  
Waschbecken am WandLavabo de pared  
Lavatorio ligação a parede  
Двухвентильный настенный для раковины

Finitura / Finishing	45IN	05IN	18IN
CR NL OG OL OS	357,00	271,00	235,00
FINITURE SPECIALI * SPECIAL FINISHING	523,00	437,00	401,00
GO RG	671,00	585,00	549,00

## Art. 2308

## Batteria lavabo scarico automatico

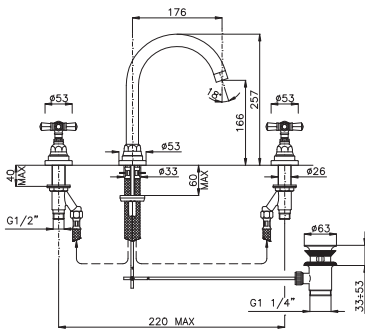
Wash basin mixer with automatic pop-up waste  
Mélangeur pour lavabo avec vidage automatique  
Waschbeckenbatterie mit automatischem AblaufMezclador lavabo con caño central  
Grupo lavatorio c/v.d.a.  
Двухвентильный на 3 отв.с функцией слива для раковины

Finitura / Finishing	45IN	05IN	18IN
CR NL OG OL OS	406,00	320,00	284,00
FINITURE SPECIALI * SPECIAL FINISHING	523,00	437,00	401,00
GO RG	671,00	585,00	549,00

## Art. 2318

## Batteria lavabo scarico automatico

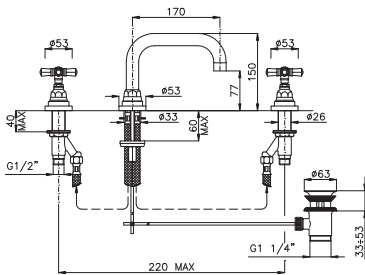
Wash basin mixer with automatic pop-up waste  
Mélangeur pour lavabo avec vidage automatique  
Waschbeckenbatterie mit automatischem AblaufMezclador lavabo con caño central  
Grupo lavatorio c/v.d.a.  
Двухвентильный на 3 отв.с функцией слива для раковины

Finitura / Finishing	45IN	05IN	18IN
CR NL OG OL OS	406,00	320,00	284,00
FINITURE SPECIALI * SPECIAL FINISHING	523,00	437,00	401,00
GO RG	671,00	585,00	549,00

## Art. 2328

## Batteria lavabo scarico automatico

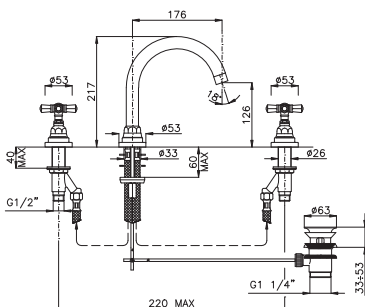
Wash basin mixer with automatic pop-up waste  
Mélangeur pour lavabo avec vidage automatique  
Waschbeckenbatterie mit automatischem AblaufMezclador lavabo con caño central  
Grupo lavatorio c/v.d.a.  
Двухвентильный на 3 отв.с функцией слива для раковины

Finitura / Finishing	45IN	05IN	18IN
CR NL OG OL OS	406,00	320,00	284,00
FINITURE SPECIALI * SPECIAL FINISHING	523,00	437,00	401,00
GO RG	671,00	585,00	549,00

## AGORÀ

Con vitone ceramico / With ceramic cartridge / Avec cartouche ceramique / Mit oberteil aus keramik / Con cabeza ceramica / Com cabeça ceramica

## Art. 2310

Combinazione bidet

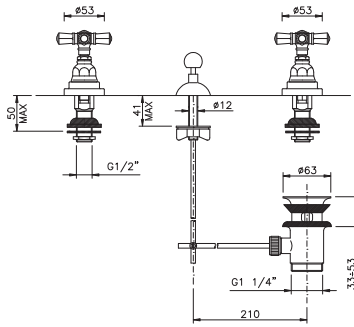

Bidet mixer with automatic pop-up waste  
Mélangeur pour bidet avec vidage automatique  
Kombination Bidet mit automatischem Ablauf

Combinacão bidé desagüe automático  
Combinacão bidet c/v.d.a.  
Двухвентильный с автоматическим сливом для биде

Finitura / Finishing	45IN	05IN	18IN
CR NL OG OL OS	282,00	196,00	160,00
FINITURE SPECIALI * SPECIAL FINISHING	414,00	328,00	292,00
GO RG	523,00	437,00	401,00

## Art. 2315

Batteria per bidet esterna

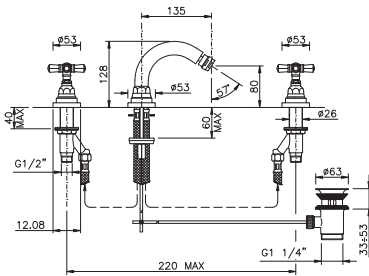

Outer group for bidet  
Groupe extérieur pour bidet  
Außengruppe für Bidet

Mezclador bidé con caõ central  
Grupo exterior para bidé  
Двухвентильный с автоматическим сливом для биде

Finitura / Finishing	45IN	05IN	18IN
CR NL OG OL OS	399,00	313,00	277,00
FINITURE SPECIALI * SPECIAL FINISHING	523,00	437,00	401,00
GO RG	671,00	585,00	549,00

## Art. 2311

Batteria bidet con doccetta

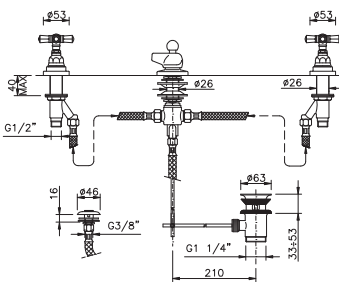

Bidet set with shower  
Mélangeur de bidet avec douche  
Bidetbatterie mit Handbrause

Combinacão bidé con churro ducha  
Combinacão bidet c/repicho  
Двухвентильный с душиком на 3 отверстия для биде

Finitura / Finishing	45IN	05IN	18IN
CR NL OG OL OS	442,00	356,00	320,00
FINITURE SPECIALI * SPECIAL FINISHING	583,00	497,00	461,00
GO RG	747,00	661,00	625,00

## Art. 2312

Rubinetto d'arresto incasso 1/2"

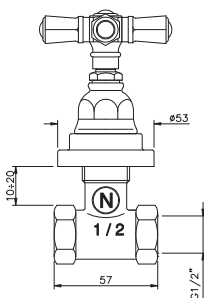

Built-in stop cock 1/2"  
Robinet arrê 1/2"  
Unterputz-Sperventil 1/2"

Válvula de cierre empotrada 1/2"  
Passador de encastrar 1/2"  
Вентиль запорный 1/2"

Finitura / Finishing	45IN	05IN	18IN
CR NL OG OL OS	142,00	99,00	81,00
FINITURE SPECIALI * SPECIAL FINISHING	167,00	124,00	106,00
GO RG	202,00	159,00	141,00

## AGORÀ

Con vitone ceramico / With ceramic cartridge / Avec cartouche ceramice / Mit oberteil aus keramik / Con cabeza ceramica / Com cabeça ceramica

## Art. 2336

Monoforo lavabo scarico automatico

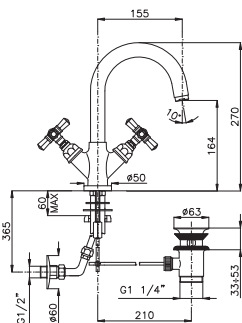

Basin single-hole mixer with automatic pop-up waste  
Mélangeur lavabo monotrou avec vidage automatique  
Einloch-Waschbecken mit automatischem Ablauf

Monohueco lavabo con desagüe automático  
Monofuro lavatorio c/v.d.a.  
Двухвентильный с автоматическим сливом для раковины

## Finitura / Finishing

**45IN** **18IN**CR NL OG OL OS **393,00** **271,00**FINITURE SPECIALI \*  
SPECIAL FINISHING **490,00** **368,00**GO RG **666,00** **544,00**

## Art. 2337

Monoforo bidet scarico automatico

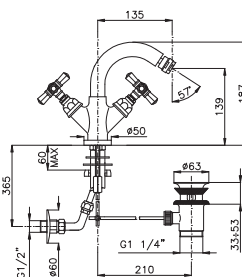

Bidet single-hole mixer with automatic pop-up waste  
Mélangeur bidet monotrou avec vidage automatique  
Einloch-Bidet mit automatischem Ablauf

Monohueco lbidé con desagüe automático  
Monofuro bidet c/v.d.a.  
Двухвентильный с автоматическим сливом для биде

## Finitura / Finishing

**45IN** **18IN**CR NL OG OL OS **380,00** **258,00**FINITURE SPECIALI \*  
SPECIAL FINISHING **475,00** **353,00**GO RG **657,00** **535,00**

## Art. 2314

Gruppo bordo vasca 5 fori

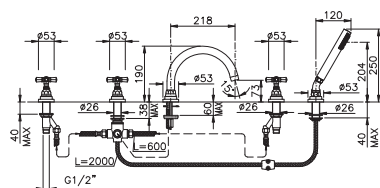

Bathtub mixer on edge type with 5 holes  
Mélangeur bain sur le bord avec 5 trous  
Gruppe für 5-Loch Badewannenrand

Mezclador de repisa para baño-ducha  
Grupo lateral de banheira de 5 furos  
Двухвентильный на 5 отверстий на борт ванны

## Finitura / Finishing

**45IN** **05IN** **18IN**CR NL OG OL OS **731,00** **602,00** **548,00**FINITURE SPECIALI \*  
SPECIAL FINISHING **932,00** **803,00** **749,00**GO RG **1.247,00** **1.118,00** **1.064,00**

## Art. 2324

Gruppo bordo vasca 5 fori

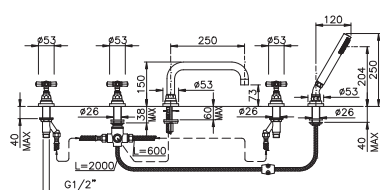

Bathtub mixer on edge type with 5 holes  
Mélangeur bain sur le bord avec 5 trous  
Gruppe für 5-Loch Badewannenrand

Mezclador de repisa para baño-ducha  
Grupo lateral de banheira de 5 furos  
Двухвентильный на 5 отверстий на борт ванны

## Finitura / Finishing

**45IN** **05IN** **18IN**CR NL OG OL OS **731,00** **602,00** **548,00**FINITURE SPECIALI \*  
SPECIAL FINISHING **932,00** **803,00** **749,00**GO RG **1.247,00** **1.118,00** **1.064,00**



serie  
**monocomandi**  
single-lever series

■ TORRE



■ ARENA



*Nicolazzi*

# Torre



**3901** *Monocomando vasca esterno con doccia*  
Single-lever bath mixer with shower



**3902** *Monocomando per lavabo con scarico automatico*  
Single-lever wash basin mixer



**3903** *Monocomando per bidet con scarico automatico*  
Single-lever bidet mixer



**3905** *Monocomando doccia esterno*  
Single-lever shower mixer, external wall type



**3925** *Monocomando doccia esterno*  
Single-lever shower mixer, external wall type



**3996** *Monocomando doccia incasso con deviatore*  
Single-lever for built-in shower with diverter



**3906** *Parte esterna monocomando doccia incasso*  
Ext. part of single-lever for built-in shower

■ TORRE



05 - Ottone Spazzolato / *Brushed Brass*

**Ecologico**  
PRODOTTO SENZA PIOMBO E NICHEL  
CON OTTONE IN LEGA ANTIDIZINCIFICANTE  
LEAD AND NICKEL FREE  
BRASS ALLOY WITHOUT ZINC

*Nicolazzi*

## MONOCOMANDO TORRE

Con cartuccia / With cartridge / Avec cartouche / Mit kartusche / Con cartucho / Com cartucho

## Art. 3901

Monocomando vasca esterno con doccia

Single-lever bath mixer with shower  
Mélangeur bain monolevier avec douche  
Einhebel-Waschbecken mit duplex Handbrause

Monomando bañera-ducha con accesorios  
Monocomando de banheira completa  
Однорычажный настенный с душем для ванны

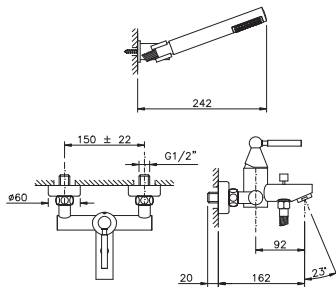

Optional Art. 5573 pag. 91

## Finitura / Finishing

CR NL OG OL OS 286,00

FINITURE SPECIALI \*  
SPECIAL FINISHING 389,00

GO RG 470,00

## Art. 3902

Monocomando per lavabo con scarico automatico

Single-lever wash basin mixer  
Mélangeur pour lavabo monolevier  
Einhebel-Waschbecken

Monomando lavabo  
Monocomando do lavatorio  
Однорычажный с автоматическим сливом для раковины

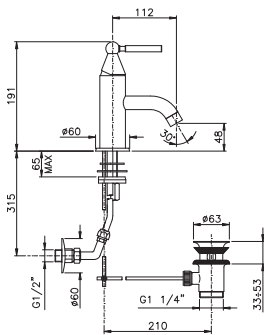

## Finitura / Finishing

CR NL OG OL OS 244,00

FINITURE SPECIALI \*  
SPECIAL FINISHING 332,00

GO RG 400,00

## Art. 3922

Monocomando per lavabo con scarico automatico

Single-lever wash basin mixer  
Mélangeur pour lavabo monolevier  
Einhebel-Waschbecken

Monomando lavabo  
Monomando de lavatorio c/v.d.a.  
Однорычажный с автоматическим сливом для раковины

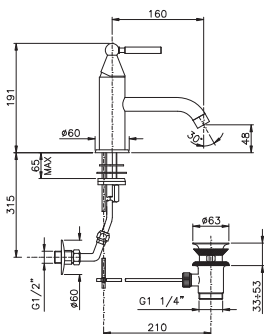

## Finitura / Finishing

CR NL OG OL OS 271,00

FINITURE SPECIALI \*  
SPECIAL FINISHING 365,00

GO RG 448,00

## Art. 3903

Monocomando per bidet con scarico automatico

Single-lever bidet mixer  
Mélangeur pour bidet monolevier  
Einhebel-Bidet mit Automatischem Ablauf

Monomando bidé  
Monocomando de bidet c/v.d.a.  
Однорычажный высокий для раковины

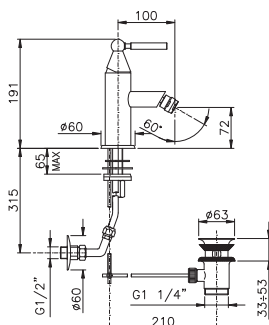

## Finitura / Finishing

CR NL OG OL OS 244,00

FINITURE SPECIALI \*  
SPECIAL FINISHING 332,00

GO RG 400,00

## MONOCOMANDO TORRE

Con cartuccia / With cartridge / Avec cartouche / Mit kartusche / Con cartucho / Com cartucho

## Art. 3905

Monocomando doccia esterno

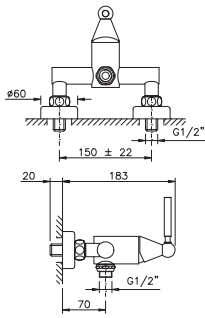

Single-lever shower mixer, external wall type  
Mélangeur monolevier, pour douche extérieure  
Aufputz-Einhebel-Dusche

Monomando ducha  
Monocomando lde base chuveiro  
Однорычажный настенный для душа

## Finitura / Finishing

CR NL OG OL OS	186,00
FINITURE SPECIALI * SPECIAL FINISHING	254,00
GO RG	306,00

## Art. 3906

Monocomando doccia incasso

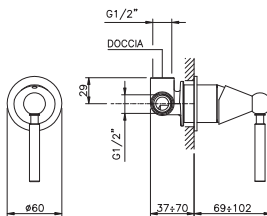

Single-lever for built-in shower  
Mono-commande douche encaissé  
Unterputz-Einhebel-Dusche

Monomando ducha empotrado  
Monomando ducha encastrado  
Однорычажный встраиваемый для душа

## Finitura / Finishing

CR NL OG OL OS	132,00
FINITURE SPECIALI * SPECIAL FINISHING	181,00
GO RG	211,00

## Art. 3925

Monocomando doccia esterno

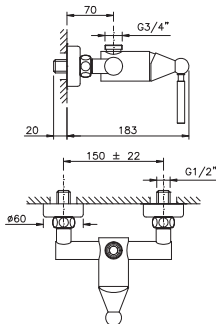

Single-lever shower mixer, external wall type  
Mélangeur monolevier, pour douche extérieure  
Aufputz-Einhebel-Dusche

Monomando ducha  
Monocomando lde base chuveiro  
Однорычажный настенный для душа

## Finitura / Finishing

CR NL OG OL OS	186,00
FINITURE SPECIALI * SPECIAL FINISHING	254,00
GO RG	306,00

## Art. 3972 - 3982

Monocomando lavabo alto

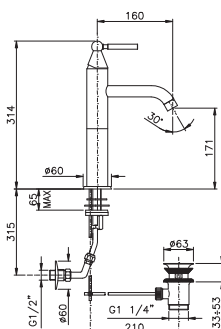

Single-lever high basin mixer  
Mélangeur lavabo haut  
Einhebel-Hochwschbecken

Monomando lavabo alto  
Monomando de lavatorio elevado  
Однорычажный высокий для раковины

## Finitura / Finishing

Finitura / Finishing	testa cieca / without pop-up waste / sans vidage mit Blindkopf / cabeza cieca / s/v.d.a.	scarico automatico / with pop-up waste / avec vidage mit Ablauf / con desagüe / c/v.d.a.
	3972	3982
CR NL OG OL OS	257,00	271,00
FINITURE SPECIALI * SPECIAL FINISHING	351,00	365,00
GO RG	424,00	448,00



## MONOCOMANDO TORRE

Con cartuccia / With cartridge / Avec cartouche / Mit kartusche / Con cartucho / Com cartucho

## Art. 3978

## Monocomando lavabo incasso

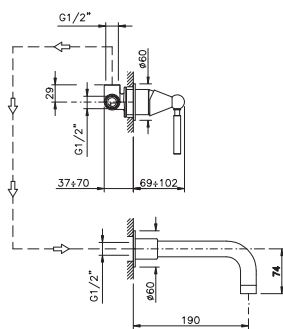

Single-lever wall mounted basin mixer  
Mélangeur lavabo encaiss  
Waschtisch eingelassen

Monomando lavabo empotrado  
Monomando de lavatório encastrado  
однорычажный для умывальника встраиваемые

## Finitura / Finishing

CR NL OG OL OS	255,00
FINITURE SPECIALI * SPECIAL FINISHING	385,00
GO RG	490,00

## Art. 3996

## Monocomando doccia incasso con deviatore

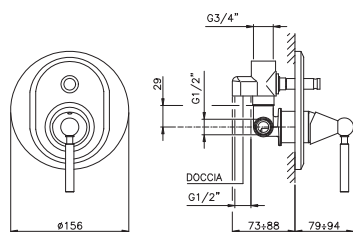

Single-lever for built-in shower with diverter  
Mono-commande douche encaiss avec aiguillage  
Einhebel eingebilten Dusche mit Ablenker

Monomando ducha empotrado con desviador  
Monocomando do chuveiro encastrado com desviador  
Однорычажный встраиваемый с переключ. для душа

## Finitura / Finishing

CR NL OG OL OS	186,00
FINITURE SPECIALI * SPECIAL FINISHING	254,00
GO RG	306,00

■ ARENA



05 - Ottone Spazzolato / *Brushed Brass*

**Ecologico**  
PRODOTTO SENZA PIOMBO E NICKEL  
CON OTTONE IN LEGA ANTIDIZINCIFICANTE  
LEAD AND NICKEL FREE  
BRASS ALLOY WITHOUT ZINC

*Nicolazzi*

# Arena



**4101** *Monocomando vasca esterno con doccia*  
Single-lever bath mixer with shower



**4102** *Monocomando per lavabo con scarico automatico*  
Single-lever wash basin mixer



**4103** *Monocomando per bidet con scarico automatico*  
Single-lever bidet mixer



**4105** *Monocomando doccia esterno*  
Single-lever shower mixer, external wall type



**4125** *Monocomando doccia esterno*  
Single-lever shower mixer, external wall type



**4196** *Monocomando doccia incasso con deviatore*  
Single-lever for built-in shower with diverter



**4106** *Parte esterna monocomando doccia incasso*  
Ext. part of single-lever for built-in shower



**\*\*48 Arena**

## MONOCOMANDO ARENA

Con cartuccia progressiva / With progressive cartridge / Avec cartouche progressive / Mit progressiver Kartusche / Con el cartucho progresivo / Com cartucho progresivo

## Art. 4101

Monocomando vasca esterno con doccia

Single-lever bath mixer with shower  
Mélangeur bain monolevier avec douche  
Einhebel-Waschbecken mit duplex Handbrause

Monomando bañera-ducha con accesorios  
Monocomando de banheira completa  
Однорычажный настенный с душем для ванны

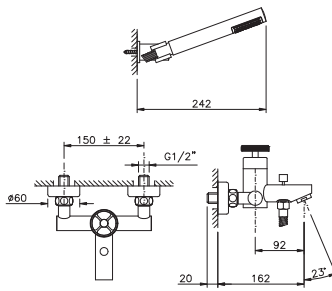

Optional Art. 5573 pag. 91

## Finitura / Finishing

48

CR NL OG OL OS 286,00

FINITURE SPECIALI \*  
SPECIAL FINISHING 389,00

GO RG 470,00

## Art. 4102

Monocomando per lavabo con scarico automatico

Single-lever wash basin mixer  
Mélangeur pour lavabo monolevier  
Einhebel-Waschbecken

Monomando lavabo  
Monocomando de lavatorio  
Однорычажный с автоматическим сливом для раковины

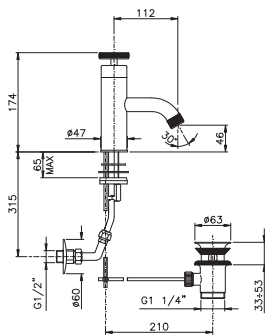

## Finitura / Finishing

48

CR NL OG OL OS 244,00

FINITURE SPECIALI \*  
SPECIAL FINISHING 332,00

GO RG 400,00

## Art. 4122

Monocomando per lavabo con scarico automatico

Single-lever wash basin mixer  
Mélangeur pour lavabo monolevier  
Einhebel-Waschbecken

Monomando lavabo  
Monomando de lavatorio c/v.d.a.  
Однорычажный с автоматическим сливом для раковины

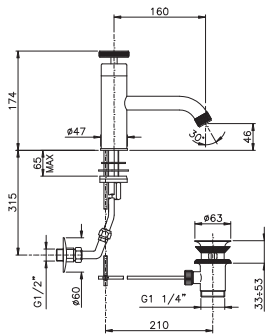

## Finitura / Finishing

48

CR NL OG OL OS 271,00

FINITURE SPECIALI \*  
SPECIAL FINISHING 365,00

GO RG 448,00

## Art. 4103

Monocomando per bidet con scarico automatico

Single-lever bidet mixer  
Mélangeur pour bidet monolevier  
Einhebel-Bidet mit Automatischem Ablauf

Monomando bidé  
Monocomando de bidet c/v.d.a.  
Однорычажный высокий для раковины

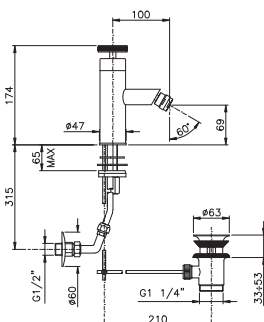

## Finitura / Finishing

48

CR NL OG OL OS 244,00

FINITURE SPECIALI \*  
SPECIAL FINISHING 332,00

GO RG 400,00

## MONOCOMANDO ARENA

Con cartuccia progressiva / With progressive cartridge / Avec cartouche progressive / Mit progressiver Kartusche / Con el cartucho progresivo / Com cartucho progresivo

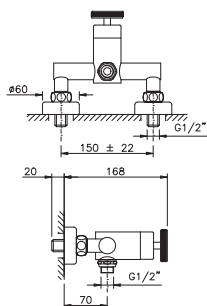

## Art. 4105

Monocomando doccia esterno

Single-lever shower mixer, external wall type  
Mélangeur monolevier, pour douche extérieure  
Aufputz-Einhebel-Dusche

Monomando ducha  
Monocomando lde base chuveiro  
Однорычажный настенный для душа

Finitura / Finishing

48

CR NL OG OL OS 186,00

FINITURE SPECIALI \*  
SPECIAL FINISHING 254,00

GO RG 306,00

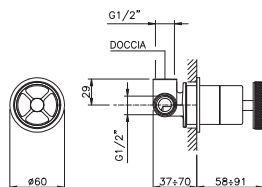

## Art. 4106

Monocomando doccia incasso

Single-lever for built-in shower  
Mono-commande douche encaissé  
Unterputz-Einhebel-Dusche

Monomando ducha empotrado  
Monomando ducha encastrado  
Однорычажный встраиваемый для душа

Finitura / Finishing

48

CR NL OG OL OS 132,00

FINITURE SPECIALI \*  
SPECIAL FINISHING 181,00

GO RG 211,00

## Art. 4125

Monocomando doccia esterno

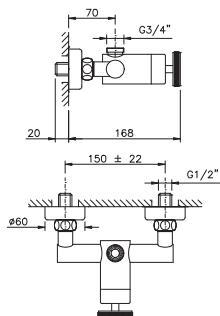

Single-lever shower mixer, external wall type  
Mélangeur monolevier, pour douche extérieure  
Aufputz-Einhebel-Dusche

Monomando ducha  
Monocomando lde base chuveiro  
Однорычажный настенный для душа

Finitura / Finishing

48

CR NL OG OL OS 186,00

FINITURE SPECIALI \*  
SPECIAL FINISHING 254,00

GO RG 306,00

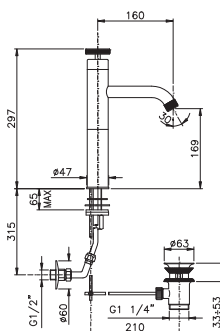

## Art. 4172 - 4182

Monocomando lavabo alto

Single-lever high basin mixer  
Mélangeur lavabo haut  
Einhebel-Hochwschbecken

Monomando lavabo alto  
Monomando de lavatorio elevado  
Однорычажный высокий для раковины

Finitura / Finishing

testa cieca / without pop-up waste / sans vidage  
mit Blindkopf / cabeza cieca / s/v.d.a.scarico automatico / with pop-up waste / avec vidage  
mit Ablauf / con desagüe / c/v.d.a.

4172

4182

CR NL OG OL OS 257,00

271,00

FINITURE SPECIALI \*  
SPECIAL FINISHING 351,00

365,00

GO RG 424,00

448,00



## MONOCOMANDO ARENA

Con cartuccia progressiva / With progressive cartridge / Avec cartouche progressive / Mit progressiver Kartusche / Con el cartucho progresivo / Com cartucho progresivo

## Art. 4178

## Monocomando lavabo incasso

Single-lever wall mounted basin mixer  
Mélangeur lavabo encaiss  
Waschtisch eingelassen

Monomando lavabo empotrado  
Monomando de lavatorio encastrado  
Однорычажный для умывальника встраиваемые

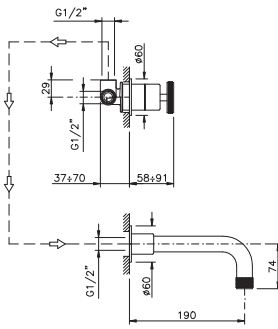

## Finitura / Finishing

48

CR NL OG OL OS	255,00
FINITURE SPECIALI * SPECIAL FINISHING	385,00
GO RG	490,00

## Art. 4196

## Monocomando doccia incasso con deviatore

Single-lever for built-in shower with diverter  
Mono-commande douche encaiss avec aiguillage  
Einhebel eingebilteten Dusche mit Ablenker

Monomando ducha empotrado con desviador  
Monocomando do chuveiro encastrado com desviador  
Однорычажный встраиваемый с перекл. для душа

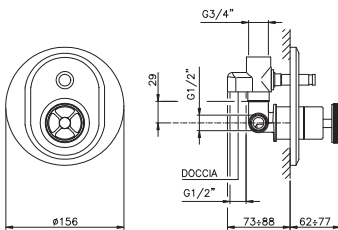

## Finitura / Finishing

48

CR NL OG OL OS	186,00
FINITURE SPECIALI * SPECIAL FINISHING	254,00
GO RG	306,00

# Programma Cucina



**3420** *Monocomando lavello cucina estraibile*  
Pull - Down sink mixer with side spray



**3430** *Monocomando lavello cucina estraibile*  
Pull - Down sink mixer with side spray



**3306** *Monoforo lavello*  
Single-hole sink mixer



**2306** *Monoforo lavello*  
Single-hole sink mixer

# programma cucina

- KITCHEN PULL-DOWN
- KITCHEN



NS - Nichel Satinato / *Satin Nickel*



CR - Cromo / *Chrome*

**Ecologico**  
 PRODOTTO SENZA PIOMBO E NICHEL  
 CON OTTONE IN LEGA ANTIDIZINCIFICANTE  
 LEAD AND NICKEL FREE  
 BRASS ALLOY WITHOUT ZINC

*Nicolazzi*

## PROGRAMMA CUCINA

Con cartuccia / With cartridge / Avec cartouche / Mit kartusche / Con cartucho / Com cartucho

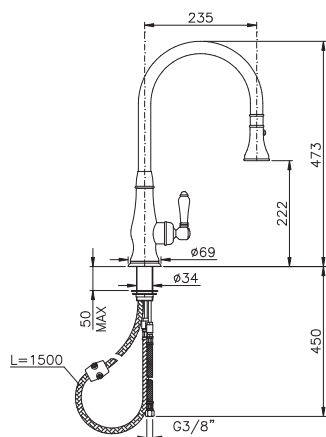

## Kitchen Pull-down Art. 3420

Monocomando lavello doccia estraibile

One-hole Pull-Down sink mixer with side spray  
Mélangeur d'évier mono. avec bec pivotant  
Einhebel-Waschbecken mit drehbaren Auslauf

Monomando fregadero encimera  
Monocomando lava louça lig. a banca  
Смеситель для мойки с выдвигаемым распылителем

Finitura / Finishing	EL CAPITAN	P.M. BLANC	P.M. BLANC A	FOREST
	<b>75P</b>	<b>76P</b>	<b>76AP</b>	<b>77P</b>
CR NL OG OL OS	366,00	374,00	382,00	372,00
FINITURE SPECIALI * SPECIAL FINISHING	504,00	507,00	526,00	511,00
GO RG	768,00	772,00	801,00	779,00

## Kitchen Pull-down Art. 3430

Monocomando lavello minimale doccia estraibile

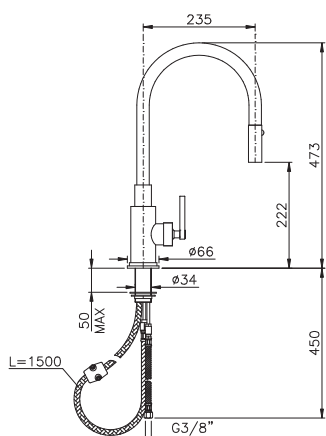

One-hole Pull-Down sink mixer with side spray  
Mélangeur d'évier mono. avec bec pivotant  
Einhebel-Waschbecken mit drehbaren Auslauf

Monomando fregadero encimera  
Monocomando lava louça lig. a banca  
Смеситель для мойки с выдвигаемым распылителем

Finitura / Finishing	
CR NL OG OL OS	366,00
FINITURE SPECIALI * SPECIAL FINISHING	504,00
GO RG	768,00

## Torre Art. 3904

Monocomando lavello a parete

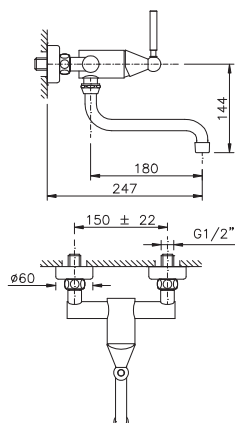

Single-lever sink mixer, wall mounted  
Mélangeur d'évier monolevier  
Wandeinhebel-Waschbecken

Monomando fregadero de pared  
Monocomando lava louça lig. a parede  
Однорычажный настенный для раковины

Finitura / Finishing	
CR NL OG OL OS	210,00
FINITURE SPECIALI * SPECIAL FINISHING	292,00
GO RG	365,00

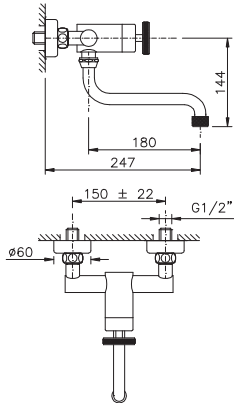
**Arena Art. 4104***Monocomando lavello a parete*Single-lever sink mixer, wall mounted  
Mélangeur d'évier monolevier  
Wandeinhebel-WaschbeckenMonomando fregadero de pared  
Monocomando lava louça lig. a parede  
Однорычажный настенный для раковины

Finitura / Finishing

ARENA

**48**

CR NL OG OL OS

210,00

FINITURE SPECIALI \*  
SPECIAL FINISHING

292,00

GO RG

365,00

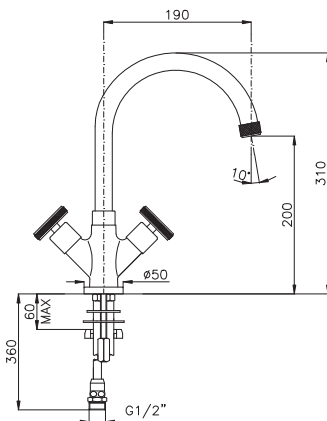
**Arena Art. 3306***Monoforo lavello*Single-hole sink mixer  
Mélangeur évier monotrou  
Einloch-WaschbeckenMezclador fregadero  
Monofuro de lava louça  
Двухвентильный на 1 отверстие для раковины

Finitura / Finishing

ARENA

**44**

CR NL OG OL OS

253,00

FINITURE SPECIALI \*  
SPECIAL FINISHING

312,00

GO RG

444,00

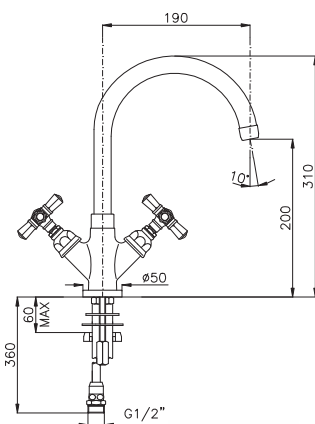
**Agorà Art. 2306***Monoforo lavello*Single-hole sink mixer  
Mélangeur évier monotrou  
Einloch-WaschbeckenMezclador fregadero  
Monofuro de lava louça  
Двухвентильный на 1 отверстие для раковины**\*\*45IN****\*\*18IN**

Finitura / Finishing

**45IN****18IN**

CR NL OG OL OS

342,00

220,00

FINITURE SPECIALI \*  
SPECIAL FINISHING

393,00

271,00

GO RG

508,00

386,00



# Termostatico



**4909** *Parte esterna termostatico a incasso da 3/4" con arresto*  
Ext. type built-in therm. 3/4"  
with stop cock



**4914** *Parte esterna termostatico a incasso da 3/4" senza arresto*  
Ext. type built-in therm. 3/4"  
without stop cock



**4912** *Parte esterna rubinetto arresto incasso 3/4"*  
External part built-in stop  
cock 3/4"



**\*\*16**



**\*\*05IN**



**\*\*18IN**



**\*\*45IN**



**\*\*44**

## ■ TERMOSTATICO



**Ecologico**  
PRODOTTO SENZA PIOMBO E NICKEL  
CON OTTONE IN LEGA ANTIDIZINCIFICANTE  
LEAD AND NICKEL FREE  
BRASS ALLOY WITHOUT ZINC

*Nicolazzi*

## TERMOSTATICO

## INFORMAZIONI TECNICHE

## TECHNICAL INFORMATION - INFORMATIONS TÉCNIQUES - TECHNISCHE INFORMATIONEN

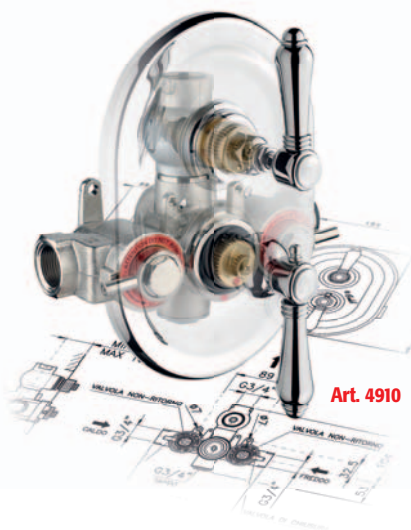

Art. 4910

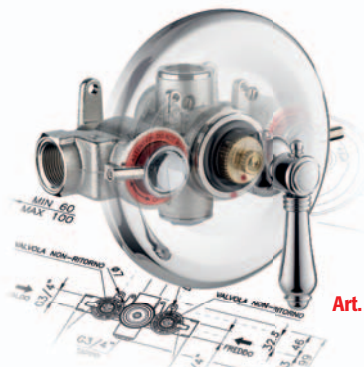

Art. 4913

Questo articolo deve sempre essere abbinato all'art. 4911  
This article must always be coupled with art. 4911

## INFORMAZIONI TECNICHE

**TEMPERATURA DI ALIMENTAZIONE ACQUA CALDA**

Minima: 48°C  
Massima: 85°C  
Consigliata: 60°C

**PRESSIONE DI ALIMENTAZIONE**

Minima: 1 bar  
Massima: 5 bar  
Consigliata: 3 bar

**IMPORTANTE:**

Le pressioni di alimentazione dell'acqua calda e fredda devono essere uguali.  
Differenza massima accettata fra le due pressioni: 1 bar.

**PORTATA**

33 l/min a 2,5 bar

**TARATURA DI FABBRICA DELLA CARTUCCIA TERMOSTATICA 38°C.**

Parametri di taratura.  
Acqua calda: 60°C/3 bar  
Acqua fredda: 15°C/3 bar

**ATTACCHI**

Entrata acqua calda e fredda = G 3/4"  
Uscita doccia e vasca = G 3/4"

**DISPOSITIVI DI SICUREZZA**

Blocco manuale della temperatura a 38°.  
Blocco automatico erogazione acqua in caso di mancanza di acqua fredda o acqua calda.  
Valvole anti-ritorno e sistema filtrante interno ispezionabili anche dopo il montaggio.

## TECHNICAL INFORMATION

**HOT WATER TEMPERATURE**

Minimum: 48°C  
Maximum: 85°C  
Recommended: 60°C

**PRESSURE**

Minimum: 1 bar  
Maximum: 5 bar  
Recommended: 3 bar

**IMPORTANT:**

The pressure alimention of hot and cold water have to be the same.  
Maximum difference accepted between the two pressures: 1 bar.

**FLOW RATE**

33 l/m at 2.5 bar

**FACTORY SETTING OF THE THERMOSTATIC CARTRIDGE 38°C**

Setting test conditions:  
Hot water: 60°C/3 bar  
Cold water: 15°C/3 bar

**CONNECTION DIMENSIONS**

Hot and cold water inlets = 3/4" G  
Shower and tub outlet = 3/4" G

**SAFETY INFORMATION**

Manual stop temperature at 38°C.  
Automatic stop of the water in case of cold water lack.  
Check valves and filters inside.

## INFORMATIONS TÉCNIQUES

**TEMPERATURE D'ALIMENTATION DE L'EAU CHAUDE**

Minimum: 48°C  
Maximum: 85°C  
Conseillé: 60°C

**PRESSION D'ALIMENTATION**

Minimum: 1 bar  
Maximum: 5 bar  
Conseillé: 3 bar

**IMPORTANT:**

les pressions d'alimentation de l'eau chaude et froide doivent être les mêmes.  
La différence au maximum acceptée est de 1 bar.

**CAPACITÉ**

33 l/min à 2,5 bar

**ÉTALLONAGE DE L'USINE DE LA CARTOUCHE THERMOSTATIQUE 38°C**

Paramètres d'étallonage  
Eau chaude: 60°C/3 bar  
Eau Froide: 15°C/3 bar

**ATTAQUES**

Entrée de l'eau chaude et froide = G 3/4"  
Sortie mélangeur douche et bain = G 3/4"

**DISPOSITIFS DE SECURITÉ**

Bloc manuel de la température à 38 °C.  
Bloc automatique de l'eau de distribution en cas de manque de l'eau froide ou de l'eau chaude.  
Soupape auto-retour et arrange inspectable intérieur disjoint également après l'assemblage.

## TECHNISCHE INFORMATIONEN

**TEMPERATUR DES EINZIEHEN DES WARMEN WASSER**

Minimum: 48°C  
Maximum: 85°C  
Fähigkeit: 60°C

**ERHÖHUNG DRUCK**

Minimum: 1 bar  
Maximum: 5 bar  
Fähigkeit: 3 bar

**WICHTIG:**

der Erhöhung Druck des warmen und kalten Wassers muß gleich sein.  
Der geltende maximale Unterschied zwischen dem zwei Druck: 1 bar

**KAPAZITÄT**

33 l/min an 2,5 bar

**KALIBRIERUNG DER FABRIK DER THERMOSTATISCHEN KARTUSCHE 38°C**

Parameter der Kalibrierung  
Warm Wasser: 60°C/3 bar  
Kalt Wasser: 15°C/3 bar

**ANGRIFF**

Eingang warmes und kaltes Wasser = G 3/4"  
Ausgang Dusche und Badewanne = G 3/4"

**EINHEIT DER DRINGLICHKEIT**

Manueller Block des Gewehr-Verteilung Wassers des Temperaturblockes.  
Automatischen im kalten Wasser des Mangelfalles oder in den warmen. Wasserventilen der Nichrückgabe und ordnet undichtet inneres.

## TERMOSTATICO

## Art. 4910

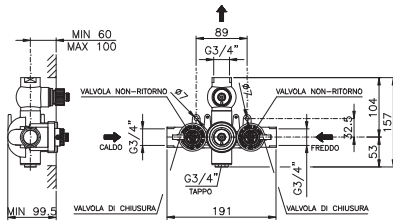

(\*) = Disponibile kit di prolunga h. 20 mm. cad.  
Available extensions kit h. 20 mm. each

Built-in type therm. 3/4" with stop cock  
Partie int. mélangeur therm. à encastrer 3/4" robinet arrêt  
Aufputz Thermostatisch. Misch 3/4" mit Sperventil

Parte incasso termostatico a incasso da 3/4" con arresto

Parte int. mezclador termost. empot. 3/4" grifo de cierre  
Partie int. mezclador termost. encaixe 3/4" torneira de parada  
Встраиваемая часть термостата 3/4" с запорным вентилем

Questo articolo deve sempre essere abbinato all'art. 4909 / This article must always be coupled with art. 4909

374,00

INFORMAZIONI TECNICHE - TECHNICAL INFORMATION - INFORMATIONS TÉCNIQUES - TECHNISCHE INFORMATIONEN - PAG. 48

## Liberty Art. 4909--16

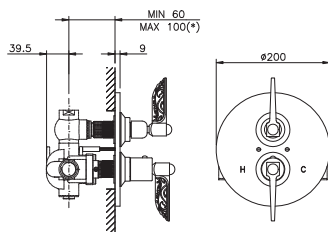

(\*) = Disponibile kit di prolunga h. 20 mm. cad.  
Available extensions kit h. 20 mm. each

Ext. type built-in therm. 3/4" with stop cock  
Partie ext. mélangeur therm. à encastrer 3/4" robinet arrêt  
Aufputz Thermostatisch. Unterputz-Misch 3/4" mit Sperventil

Parte esterna termostatico a incasso da 3/4" con arresto

Parte ext. mezclador termost. empot. 3/4" grifo de cierre  
Base ext. mezclador termost. encaixe 3/4" torneira de parada  
Наружная часть встр.термостата 3/4" с запорным вентилем

Finitura / Finishing

16

CR NL OG OL OS 402,00

FINITURE SPECIALI \*  
SPECIAL FINISHING 771,00

GO RG 891,00

## Arena Art. 4909--44

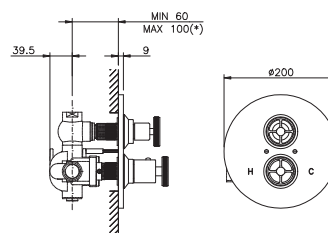

(\*) = Disponibile kit di prolunga h. 20 mm. cad.  
Available extensions kit h. 20 mm. each

Ext. type built-in therm. 3/4" with stop cock  
Partie ext. mélangeur therm. à encastrer 3/4" robinet arrêt  
Aufputz Thermostatisch. Unterputz-Misch 3/4" mit Sperventil

Parte esterna termostatico a incasso da 3/4" con arresto

Parte ext. mezclador termost. empot. 3/4" grifo de cierre  
Base ext. mezclador termost. encaixe 3/4" torneira de parada  
Наружная часть встр.термостата 3/4" с запорным вентилем

Finitura / Finishing

44

CR NL OG OL OS 240,00

FINITURE SPECIALI \*  
SPECIAL FINISHING 551,00

GO RG 619,00

## Agorà Art. 4909--\*\*

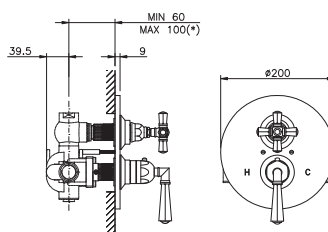

(\*) = Disponibile kit di prolunga h. 20 mm. cad.  
Available extensions kit h. 20 mm. each

Ext. type built-in therm. 3/4" with stop cock  
Partie ext. mélangeur therm. à encastrer 3/4" robinet arrêt  
Aufputz Thermostatisch. Unterputz-Misch 3/4" mit Sperventil

Parte esterna termostatico a incasso da 3/4" con arresto

Parte ext. mezclador termost. empot. 3/4" grifo de cierre  
Base ext. mezclador termost. encaixe 3/4" torneira de parada  
Наружная часть встр.термостата 3/4" с запорным вентилем

Finitura / Finishing

45IN

05IN

18IN

CR NL OG OL OS 280,00 233,00 209,00

FINITURE SPECIALI \*  
SPECIAL FINISHING 620,00 515,00 479,00

GO RG 691,00 575,00 539,00

## TERMOSTATICO

## Art. 4913

Parte incasso termostatico 3/4" senza rubinetto arresto

Built-in type therm. 3/4" without stop cock  
 Partie int. mélangeur therm. à encastrer 3/4" sans robinet arrêt  
 Aufputz Thermostatisch. Misch 3/4" ohne Sperrventil

Parte interior mezclador termostático sin grifo de cierre  
 Parte interna misturador termostático sem tomeira de parada  
 Встраиваемая часть термостата 3/4" без запорного вентиля

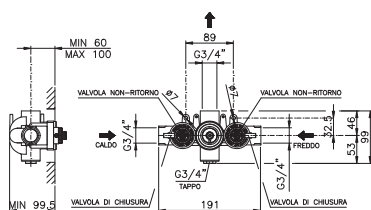

(\*) = Disponibile kit di prolunga h. 20 mm. cad.  
 Available extensions kit h. 20 mm. each

Questo articolo deve sempre essere abbinato all'art. 4914 / This article must always be coupled with art. 4914

329,00

INFORMAZIONI TECNICHE - TECHNICAL INFORMATION - INFORMATIONS TÉCNIQUES - TECHNISCHE INFORMATIONEN - PAG. 48

## Liberty Art. 4914--16

Parte esterna termostatico a incasso 3/4" senza arresto

Ext. type built-in therm. 3/4" without stop cock  
 Partie ext. mélangeur therm. à encastrer 3/4" sans robinet arrêt  
 Aufputz Thermostatisch. Unterputz-Misch 3/4" ohne Sperrventil

Parte exterior mezclador termostático sin grifo de cierre  
 Parte externa misturador termostático sem tomeira de parada  
 Наружная часть встр. термостата 3/4" без запорного вентиля

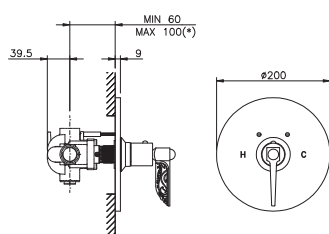

(\*) = Disponibile kit di prolunga h. 20 mm. cad.  
 Available extensions kit h. 20 mm. each

Finitura / Finishing

16

CR NL OG OL OS 340,00

FINITURE SPECIALI \*  
SPECIAL FINISHING 649,00

GO RG 752,00

## Arena Art. 4914--44

Parte esterna termostatico a incasso 3/4" senza arresto

Ext. type built-in therm. 3/4" without stop cock  
 Partie ext. mélangeur therm. à encastrer 3/4" sans robinet arrêt  
 Aufputz Thermostatisch. Unterputz-Misch 3/4" ohne Sperrventil

Parte exterior mezclador termostático sin grifo de cierre  
 Parte externa misturador termostático sem tomeira de parada  
 Наружная часть встр. термостата 3/4" без запорного вентиля

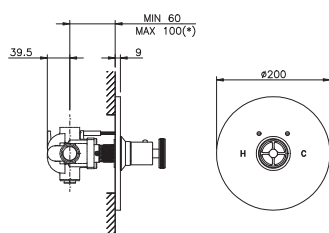

(\*) = Disponibile kit di prolunga h. 20 mm. cad.  
 Available extensions kit h. 20 mm. each

Finitura / Finishing

44

CR NL OG OL OS 164,00

FINITURE SPECIALI \*  
SPECIAL FINISHING 417,00

GO RG 469,00

## Agorà Art. 4914--05

Parte esterna termostatico a incasso 3/4" senza arresto

Ext. type built-in therm. 3/4" without stop cock  
 Partie ext. mélangeur therm. à encastrer 3/4" sans robinet arrêt  
 Aufputz Thermostatisch. Unterputz-Misch 3/4" ohne Sperrventil

Parte exterior mezclador termostático sin grifo de cierre  
 Parte externa misturador termostático sem tomeira de parada  
 Наружная часть встр. термостата 3/4" без запорного вентиля

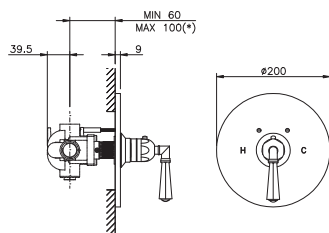

(\*) = Disponibile kit di prolunga h. 20 mm. cad.  
 Available extensions kit h. 20 mm. each

Finitura / Finishing

METAL

05

CR NL OG OL OS 156,00

FINITURE SPECIALI \*  
SPECIAL FINISHING 382,00

GO RG 428,00



## TERMOSTATICO

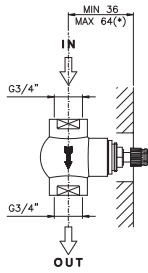

(\*) = Disponibile kit di prolunga h. 40 mm. cad.  
Available extensions kit h. 40 mm. each

## Art. 4911

Built-in part stop cock 3/4"  
Partie interieure robinet d'arrêt 3/4"  
Unterputzseite Sperrventil 3/4"

Parte incasso rubinetto arresto 3/4"

Parte empotrada de grifo de cierre 3/4"  
Base encastrada do passador 3/4"  
Встраиваемая часть запорного вентиля 3/4"

Questo articolo deve sempre essere abbinato all'art. 4912 / This article must always be coupled with art. 4912

48,00

## Liberty Art. 4912--16

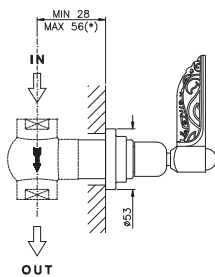

(\*) = Disponibile kit di prolunga h. 40 mm. cad.  
Available extensions kit h. 40 mm. each

External part built-in stop cock 3/4"  
Partie exterieure robinet d'arrêt 3/4"  
Aufputzseite Unterputz-Sperrventil 3/4"

Parte esterna rubinetto arresto incasso 3/4"

Parte esterna grifo de cierre empotrado. 3/4"  
Base externa passador de encastrar 3/4"  
Наружная часть запорного вентиля 3/4"

Finitura / Finishing

16

CR NL OG OL OS 201,00

FINITURE SPECIALI \*  
SPECIAL FINISHING 350,00

GO RG 390,00

## Arena Art. 4912--44

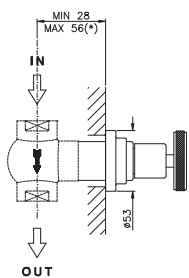

(\*) = Disponibile kit di prolunga h. 40 mm. cad.  
Available extensions kit h. 40 mm. each

External part built-in stop cock 3/4"  
Partie exterieure robinet d'arrêt 3/4"  
Aufputzseite Unterputz-Sperrventil 3/4"

Parte esterna rubinetto arresto incasso 3/4"

Parte esterna grifo de cierre empotrado. 3/4"  
Base externa passador de encastrar 3/4"  
Наружная часть запорного вентиля 3/4"

Finitura / Finishing

44

CR NL OG OL OS 84,00

FINITURE SPECIALI \*  
SPECIAL FINISHING 135,00

GO RG 149,00

## Agorà Art. 4912--\*\*

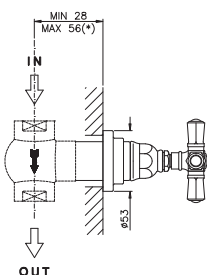

(\*) = Disponibile kit di prolunga h. 40 mm. cad.  
Available extensions kit h. 40 mm. each

External part built-in stop cock 3/4"  
Partie exterieure robinet d'arrêt 3/4"  
Aufputzseite Unterputz-Sperrventil 3/4"

Parte esterna rubinetto arresto incasso 3/4"

Parte esterna grifo de cierre empotrado. 3/4"  
Base externa passador de encastrar 3/4"  
Наружная часть запорного вентиля 3/4"

Finitura / Finishing

45IN

05IN

18IN

CR NL OG OL OS 96,00 80,00 73,00

FINITURE SPECIALI \*  
SPECIAL FINISHING 162,00 135,00 117,00

GO RG 180,00 149,00 130,00



# accessori bagno

bathroom accessories

---

■ LIBERTY



---

■ ARENA



---

■ AGORÀ



---

■ MONTE CROCE

---



*Nicolazzi*

# accessori bagno Liberty



**1081** *Appendiabiti*  
Clothes-hanger



**1082** *Portasalvietta a snodo*  
Jointed towel holder



**1087** *Portasapone*  
Soap holder



**1088** *Portabicchiere*  
Tumbler holder



**1089** *Dosasapone*  
Soap dispenser holder



**1094** *Portasapone e bicchiere  
d'appoggio*  
Soap holder with tumbler  
holder

# accessori bagno

LIBERTY



*Nicolazzi*



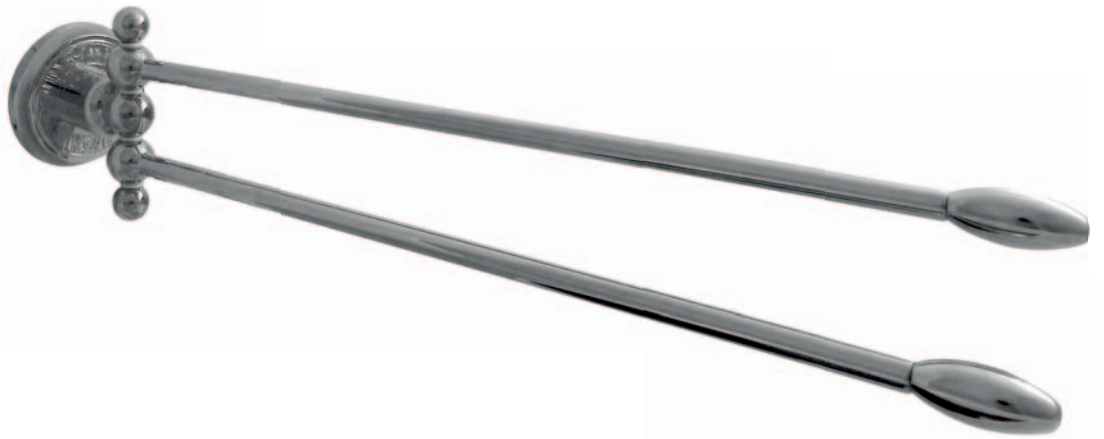

## ACCESSORI BAGNO liberty



## ACCESSORI BAGNO liberty

## Art. 1080

Mensola cm. 60

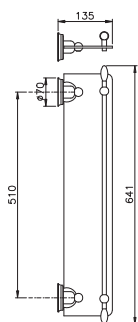

Shelf cm. 60  
Étagère cm. 60  
Ablage cm. 60

Repisa cm. 60  
Prateleira cm. 60  
Полочка 60 см

Finitura / Finishing

16

CR NL OG OL OS 285,00

FINITURE SPECIALI \*  
SPECIAL FINISHING 388,00

GO RG 456,00

## Art. 1081

Appendiabiti

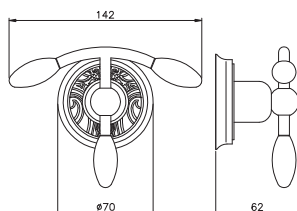

Clothes-hanger  
Vêtements-cintre  
Kleidung-Aufhänger

Percha  
Cabide  
Крючок

Finitura / Finishing

16

CR NL OG OL OS 135,00

FINITURE SPECIALI \*  
SPECIAL FINISHING 184,00

GO RG 210,00

## Art. 1082

Portasalvietta a snodo

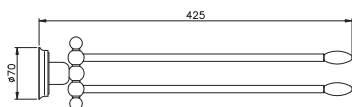

Jointed towel holder  
Porte serviette réglable  
Handtuchhalter

Toallero articulable  
Toalheiro articulado  
Держатель полотенец полочка

Finitura / Finishing

16

CR NL OG OL OS 237,00

FINITURE SPECIALI \*  
SPECIAL FINISHING 332,00

GO RG 380,00

## Art. 1083

Portasalvietta cm.35

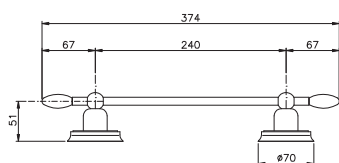

Towel holder cm. 35  
Porte serviette cm. 35  
Handtuchhalter cm. 35

Toallero cm. 35  
Toalheiro cm. 35  
Держатель полотенца 35 см

Finitura / Finishing

16

CR NL OG OL OS 213,00

FINITURE SPECIALI \*  
SPECIAL FINISHING 290,00

GO RG 331,00

## Art. 1084

Portasalvietta cm. 50

Towel holder cm. 50  
 Porte serviette cm. 50  
 Handtuchhalter cm. 50

Toallero cm. 50  
 Toalheiro cm. 50  
 Держатель полотенца 50 см

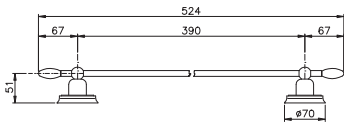

Finitura / Finishing

16

CR NL OG OL OS 220,00

FINITURE SPECIALI \*  
SPECIAL FINISHING 299,00

GO RG 341,00

## Art. 1085

Portasalvietta ad anello

Towel ring  
 Anneau porte serviette  
 Handtuchring

Toallero de anilla  
 Toalheiro argola  
 Держатель полотенца кольцо

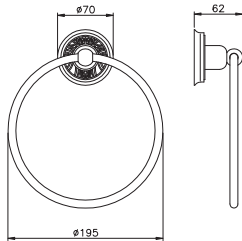

Finitura / Finishing

16

CR NL OG OL OS 187,00

FINITURE SPECIALI \*  
SPECIAL FINISHING 262,00

GO RG 300,00

## Art. 1086

Portasalvietta cm. 65

Towel holder cm. 65  
 Porte serviette cm. 65  
 Handtuchhalter cm. 65

Toallero cm. 65  
 Toalheiro cm. 65  
 Держатель полотенца 65 см

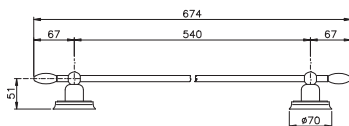

Finitura / Finishing

16

CR NL OG OL OS 222,00

FINITURE SPECIALI \*  
SPECIAL FINISHING 301,00

GO RG 343,00

## Art. 1087

Portasapone

Soap holder  
 Porte savon  
 Seifenschale

Jabonera  
 Saboneteira  
 Мыльница

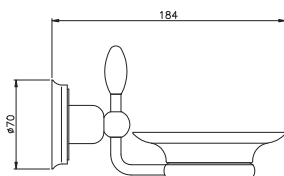

Finitura / Finishing

16

CR NL OG OL OS 156,00

FINITURE SPECIALI \*  
SPECIAL FINISHING 212,00

GO RG 243,00

## ACCESSORI BAGNO liberty

## Art. 1088

Portabicchiere

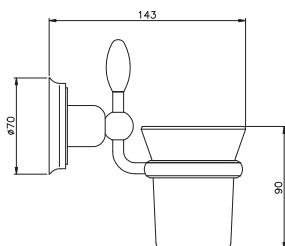

Tumbler holder  
Porte verre  
Becherhalter

Portavaso  
Porta-copos  
Стакан

Finitura / Finishing

16

CR NL OG OL OS 157,00

FINITURE SPECIALI \*  
SPECIAL FINISHING 214,00

GO RG 245,00

## Art. 1089

Dosasapone

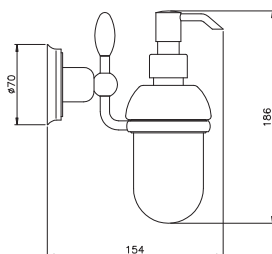

Soap dispenser holder  
Porte distributeur de savon  
Sefenspenderhalter

Dispensador de jabón  
Doseador sabão  
Дозатор для жидкого мыла

Finitura / Finishing

16

CR NL OG OL OS 206,00

FINITURE SPECIALI \*  
SPECIAL FINISHING 281,00

GO RG 321,00

## Art. 1090

Portascopino a parete

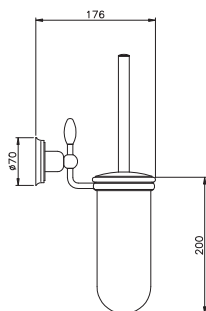

Wall toilet brush holder  
Porte balai à mur  
Wahdülslengarnitur

Escobillero de pared  
Porta-piçaba parede  
Туалетный ёршик настенный

Finitura / Finishing

16

CR NL OG OL OS 210,00

FINITURE SPECIALI \*  
SPECIAL FINISHING 286,00

GO RG 327,00

## Art. 1092

Portarotolo

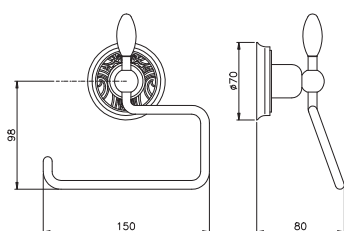

Paper holder  
Porte rouleau  
Papierrolenhalter

Portarrollo  
Porta-rolos  
Бумагодержатель

Finitura / Finishing

16

CR NL OG OL OS 142,00

FINITURE SPECIALI \*  
SPECIAL FINISHING 193,00

GO RG 221,00

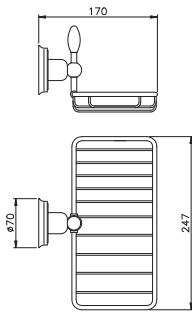

## Art. 1093

*Portasapone doppio*

Double soap holder  
Porte savon double  
Doppelseenschale

Jabonera doble en rejilla  
Saboneteira rede  
Бумагодержатель двойной

Finitura / Finishing

**16**

CR NL OG OL OS 154,00

FINITURE SPECIALI \*  
SPECIAL FINISHING 216,00

GO RG 247,00

## Art. 1094

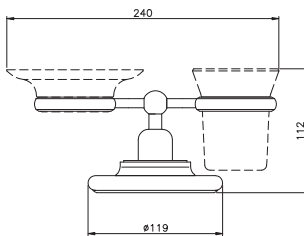
*Portasapone e bicchiere d'appoggio (senza vetri)*

SOLO PER PORTASAPONE E BICCHIERE  
ONLY FOR SOAP DISH AND TUMBLER

Soap holder with tumbler holder (without glass)  
Porte savon avec porte verre (sans vitrage)  
Saifenschale mit becherhalter (ohne glas)

Jaboneira y portavasos de encimera (sin vidrio)  
Saboneteira e copo dos dentes (sem vidro)  
Держатель мыльницы и стакана настольный (без стекло)

Finitura / Finishing

**16**

CR NL OG OL OS 210,00

FINITURE SPECIALI \*  
SPECIAL FINISHING 294,00

GO RG 336,00

## Art. 1095

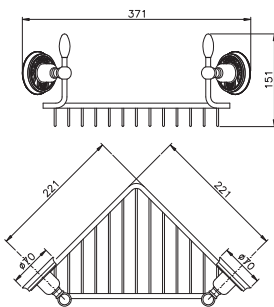
*Portasapone doppio ad angolo*

Double soap holder  
Porte savon double  
Doppelseenschale

Jabonera doble en rejilla  
Saboneteira rede  
Бумагодержатель двойной

Finitura / Finishing

**16**

CR NL OG OL OS 300,00

FINITURE SPECIALI \*  
SPECIAL FINISHING 420,00

GO RG 480,00

## Art. 1097

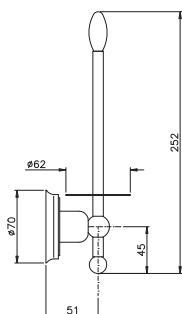
*Portarotolo verticale*

Spare paper holder  
Porte rouleau vertical  
Senkrechten Papierhalter

Portarollo verticale  
Porta-rolos verticais  
Бумагодержатель вертикальный

Finitura / Finishing

**16**

CR NL OG OL OS 174,00

FINITURE SPECIALI \*  
SPECIAL FINISHING 244,00

GO RG 279,00

## ACCESSORI BAGNO liberty

## Art. 1098

## Portasalvietta doppio

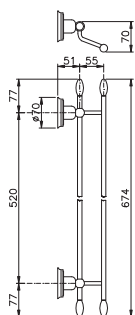

Double towel holder  
Porte serviette double  
Doppel Handtuchhalter

Toallero doble  
Toalheiro dobro  
Держатель полотенца двойной

## Finitura / Finishing

**16**

CR NL OG OL OS 280,00

FINITURE SPECIALI \*  
SPECIAL FINISHING 392,00

GO RG 448,00

## Art. 1099

## Griglia portasalviette

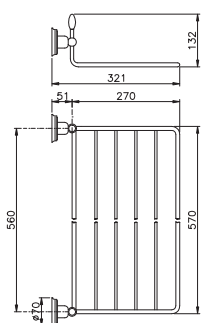

Towels rack  
Grille porte serviette  
Gitter Handtuchhalter

En rejilla toallero  
Rede toallero  
Держатель полотенец полочка

## Finitura / Finishing

**16**

CR NL OG OL OS 408,00

FINITURE SPECIALI \*  
SPECIAL FINISHING 572,00

GO RG 653,00

# accessori bagno

■ ARENA



*Nicolazzi*

# accessori bagno **Arena**



**1480** *Mensola cm. 60*  
Shelf cm. 60



**1481** *Appendiabiti*  
Clothes-hanger



**1481 M** *Appendiabiti*  
Clothes-hanger



**1482** *Portasalvietta a snodo*  
Jointed towel holder



**1483** *Portasalvietta cm. 30*  
Towel holder cm. 30

**1484** *Portasalvietta cm. 45*  
Towel holder cm. 45

**1486** *Portasalvietta cm. 60*  
Towel holder cm. 60



**1487** *Portasapone*  
Soap holder



**1488** *Portabicchiere*  
Tumbler holder



**1489** *Dosasapone*  
Soap dispenser holder



**1490** *Portascopino a parete*  
Wall toilet brush holder



**1492** *Portarotolo*  
Paper holder



**1493** *Portasapone doppio*  
Double soap holder



**1495** *Portasapone doppio ad angolo*  
Double soap holder



**1497** *Portarotolo verticale*  
Spare paper holder



**1498** *Portasalvietta doppio*  
Double towel holder



**1499** *Griglia portasalviette*  
Towels rack

## Art. 1480

Mensola cm. 60

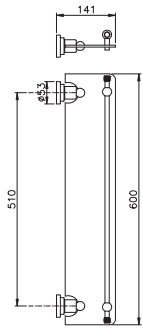
Shelf cm. 60  
Étagère cm. 60  
Ablage cm. 60Repisa cm. 60  
Prateleira cm. 60  
Полочка 60 см

## Finitura / Finishing

44

CR NL OG OL OS 165,00

FINITURE SPECIALI \*  
SPECIAL FINISHING 225,00

GO RG 292,00

## Art. 1481

Appendiabiti

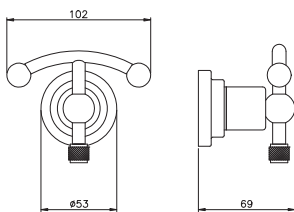
Clothes-hanger  
Vêtements-cintre  
Kleidung-AufhängerPercha  
Cabide  
Крючок

## Finitura / Finishing

44

CR NL OG OL OS 75,00

FINITURE SPECIALI \*  
SPECIAL FINISHING 102,00

GO RG 133,00

## Art. 1481 M

Appendiabiti

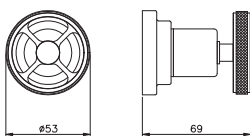
Clothes-hanger  
Vêtements-cintre  
Kleidung-AufhängerPercha  
Cabide  
Крючок

## Finitura / Finishing

44

CR NL OG OL OS 95,00

FINITURE SPECIALI \*  
SPECIAL FINISHING 122,00

GO RG 153,00

## Art. 1482

Portasalvietta a snodo

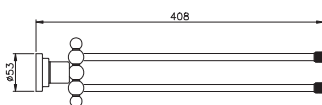
Jointed towel holder  
Porte serviette réglable  
HandtuchhalterToallero articulable  
Toalheiro articulado  
Держатель полотенце полочка

## Finitura / Finishing

44

CR NL OG OL OS 116,00

FINITURE SPECIALI \*  
SPECIAL FINISHING 154,00

GO RG 199,00



## ACCESSORI BAGNO arena

## Art. 1483

Portasalvietta cm.30

Towel holder cm. 30  
 Porte serviette cm. 30  
 Handtuchhalter cm. 30

Toallero cm. 30  
 Toalheiro cm. 30  
 Держатель полотенца 30 см

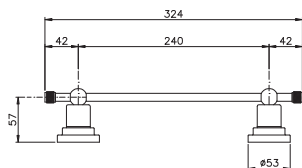

Finitura / Finishing

44

CR NL OG OL OS 108,00

FINITURE SPECIALI \*  
SPECIAL FINISHING 155,00

GO RG 201,00

## Art. 1484

Portasalvietta cm. 45

Towel holder cm. 45  
 Porte serviette cm. 45  
 Handtuchhalter cm. 45

Toallero cm. 45  
 Toalheiro cm. 45  
 Держатель полотенца 45 см

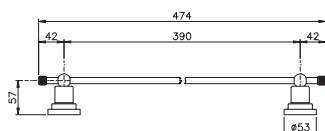

Finitura / Finishing

44

CR NL OG OL OS 117,00

FINITURE SPECIALI \*  
SPECIAL FINISHING 163,00

GO RG 212,00

## Art. 1485

Portasalvietta ad anello

Towel ring  
 Anneau porte serviette  
 Handtuchring

Toallero de anilla  
 Toalheiro argola  
 Держатель полотенца кольцо

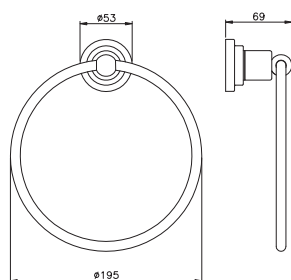

Finitura / Finishing

27

CR NL OG OL OS 86,00

FINITURE SPECIALI \*  
SPECIAL FINISHING 113,00

GO RG 141,00

## Art. 1486

Portasalvietta cm. 60

Towel holder cm. 60  
 Porte serviette cm. 60  
 Handtuchhalter cm. 60

Toallero cm. 60  
 Toalheiro cm. 60  
 Держатель полотенца 60 см

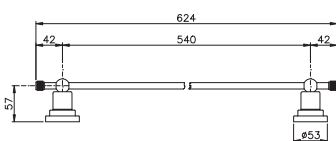

Finitura / Finishing

44

CR NL OG OL OS 117,00

FINITURE SPECIALI \*  
SPECIAL FINISHING 163,00

GO RG 212,00

## Art. 1487

Portasapone

Soap holder  
Porte savon  
Seifenschale

Jabonera  
Saboneteira  
Мыльница

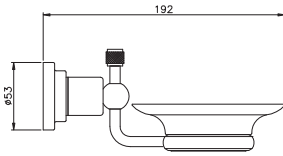

Finitura / Finishing

44

CR NL OG OL OS 81,00

FINITURE SPECIALI \*  
SPECIAL FINISHING 106,00

GO RG 137,00

## Art. 1488

Portabicchiere

Tumbler holder  
Porte verre  
Becherhalter

Portavaso  
Porta-copos  
Стакан

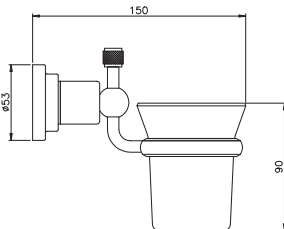

Finitura / Finishing

44

CR NL OG OL OS 82,00

FINITURE SPECIALI \*  
SPECIAL FINISHING 111,00

GO RG 143,00

## Art. 1489

Dosasapone

Soap dispenser holder  
Porte distributeur de savon  
Seifenspenderhalter

Dispensador de jabón  
Doseador sabão  
Дозатор для жидкого мыла

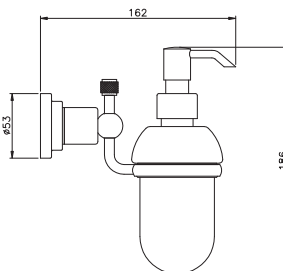

Finitura / Finishing

44

CR NL OG OL OS 121,00

FINITURE SPECIALI \*  
SPECIAL FINISHING 165,00

GO RG 214,00

## Art. 1490

Portascopino a parete

Wall toilet brush holder  
Porte balai à mur  
Wahdürslengarnitur

Escobillero de pared  
Porta-piçaba parede  
Туалетный ёршик настенный

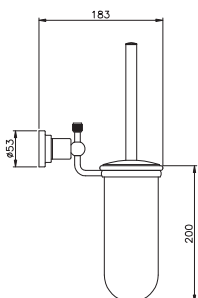

Finitura / Finishing

44

CR NL OG OL OS 124,00

FINITURE SPECIALI \*  
SPECIAL FINISHING 160,00

GO RG 208,00

## ACCESSORI BAGNO arena

## Art. 1492

Portarotolo

Paper holder  
Porte rouleau  
Papierrolenhalter

Portarollo  
Porta-rolos  
Бумагодержатель

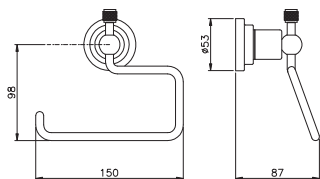

Finitura / Finishing

44

CR NL OG OL OS 81,00

FINITURE SPECIALI \*  
SPECIAL FINISHING 114,00

GO RG 148,00

## Art. 1493

Portasapone doppio

Double soap holder  
Porte savon double  
Doppelselenschale

Jabonera doble en rejilla  
Saboneteira rede  
Бумагодержатель двойной

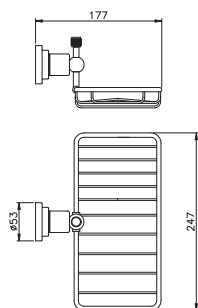

Finitura / Finishing

44

CR NL OG OL OS 98,00

FINITURE SPECIALI \*  
SPECIAL FINISHING 128,00

GO RG 166,00

## Art. 1494

Portasapone e bicchiere d'appoggio (senza vetri)

Soap holder with tumbler holder (without glass)  
Porte savon avec porte verre (sans vitrage)  
Saifenschale mit becherhalter (ohne glas)

Jaboneira y portavasos de encimera (sin vidrio)  
Saboneteira e copo dos dentes (sem vidro)  
Держатель мыльницы и стакана настольный (без стекло)

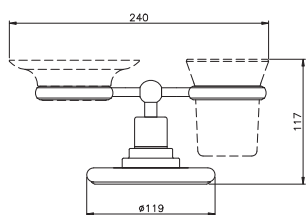

SOLO PER PORTASAPONE E BICCHIERE  
ONLY FOR SOAP DISH AND TUMBLER

Finitura / Finishing

27

CR NL OG OL OS 106,00

FINITURE SPECIALI \*  
SPECIAL FINISHING 146,00

GO RG 189,00

## Art. 1495

Portasapone doppio ad angolo

Double soap holder  
Porte savon double  
Doppelselenschale

Jabonera doble en rejilla  
Saboneteira rede  
Бумагодержатель двойной

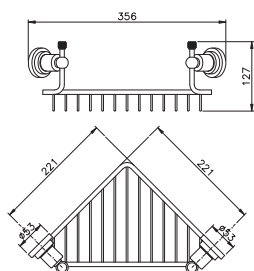

Finitura / Finishing

44

CR NL OG OL OS 227,00

FINITURE SPECIALI \*  
SPECIAL FINISHING 297,00

GO RG 385,00

## Art. 1497

## Portarotolo verticale

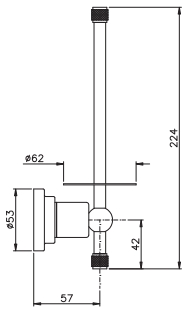

Spare paper holder  
Porte rouleau vertical  
Senkrechten Papierhalter

Portarollo verticales  
Porta-rollos verticais  
Бумагодержатель вертикальный

## Finitura / Finishing

**44**

CR NL OG OL OS 89,00

FINITURE SPECIALI \*  
SPECIAL FINISHING 124,00

GO RG 161,00

## Art. 1498

## Portasalvietta doppio

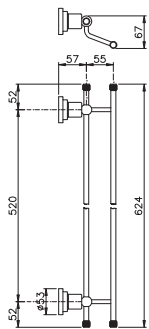

Double towel holder  
Porte serviette double  
Doppel Handtuchhalter

Toallero doble  
Toalheiro dobro  
Держатель полотенца двойной

## Finitura / Finishing

**44**

CR NL OG OL OS 159,00

FINITURE SPECIALI \*  
SPECIAL FINISHING 211,00

GO RG 274,00

## Art. 1499

## Griglia portasalviette

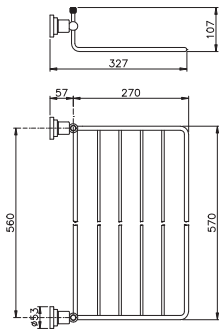

Towels rack  
Grille porte serviette  
Gitter Handtuchhalter

En rejilla toallero  
Rede toallero  
Держатель полотенца полочка

## Finitura / Finishing

**44**

CR NL OG OL OS 266,00

FINITURE SPECIALI \*  
SPECIAL FINISHING 372,00

GO RG 484,00

# accessori bagno Agorà



**1480** *Mensola cm. 60*  
Shelf cm. 60



**1481** *Appendiabiti*  
Clothes-hanger



**1482** *Portasalvietta a snodo*  
Jointed towel holder



**1485** *Portasalvietta ad anello*  
Towel ring



**1483** *Portasalvietta cm. 30*  
Towel holder cm. 30



**1487** *Portasapone*  
Soap holder



**1488** *Portabicchiere*  
Tumbler holder



**1489** *Dosasapone*  
Soap dispenser holder

**1484** *Portasalvietta cm. 45*  
Towel holder cm. 45

**1486** *Portasalvietta cm. 60*  
Towel holder cm. 60



**1490** *Portascopino a parete*  
Wall toilet brush holder



**1492** *Portarotolo*  
Paper holder



**1493** *Portasapone doppio*  
Double soap holder



**1495** *Portasapone doppio ad angolo*  
Double soap holder



**1497** *Portarotolo verticale*  
Spare paper holder



**1498** *Portasalvietta doppio*  
Double towel holder

# accessori bagno

## ■ AGORÀ



*Nicolazzi*



## ACCESSORI BAGNO agorà

## Art. 1480 IN

Mensola cm. 60

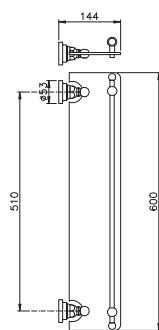

Shelf cm. 60  
Étagère cm. 60  
Ablage cm. 60

Repisa cm. 60  
Prateleira cm. 60  
Полочка 60 см

## Finitura / Finishing

CR NL OG OL OS 165,00

FINITURE SPECIALI \*  
SPECIAL FINISHING 225,00

GO RG 292,00

## Art. 1481 IN

Appendiabiti

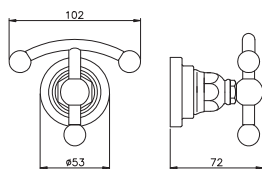

Clothes-hanger  
Vêtements-cintre  
Kleidung-Aufhänger

Percha  
Cabide  
Крючок

## Finitura / Finishing

CR NL OG OL OS 75,00

FINITURE SPECIALI \*  
SPECIAL FINISHING 102,00

GO RG 133,00

## Art. 1482 IN

Portasalvietta a snodo

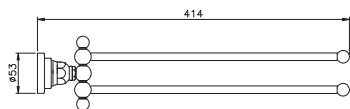

Jointed towel holder  
Porte serviette réglable  
Handtuchhalter

Toallero articulable  
Toalheiro articulado  
Держатель полотенец полочка

## Finitura / Finishing

CR NL OG OL OS 116,00

FINITURE SPECIALI \*  
SPECIAL FINISHING 154,00

GO RG 199,00

## Art. 1483 IN

Portasalvietta cm.30

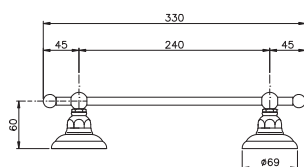

Towel holder cm. 30  
Porte serviette cm. 30  
Handtuchhalter cm. 30

Toallero cm. 30  
Toalheiro cm. 30  
Держатель полотенец 30 см

## Finitura / Finishing

CR NL OG OL OS 108,00

FINITURE SPECIALI \*  
SPECIAL FINISHING 155,00

GO RG 201,00

## Art. 1484 IN

Portasalvietta cm. 45

Towel holder cm. 45  
 Porte serviette cm. 45  
 Handtuchhalter cm. 45

Toallero cm. 45  
 Toalheiro cm. 45  
 Держатель полотенца 45 см

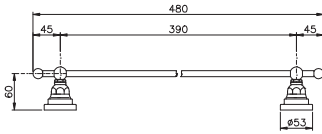

## Finitura / Finishing

CR NL OG OL OS	117,00
FINITURE SPECIALI * SPECIAL FINISHING	163,00
GO RG	212,00

## Art. 1485 IN

Portasalvietta ad anello

Towel ring  
 Anneau porte serviette  
 Handtuchring

Toallero de anilla  
 Toalheiro argola  
 Держатель полотенца кольцо

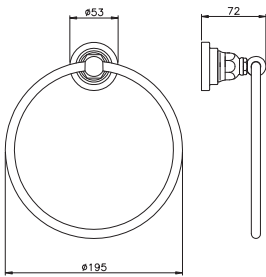

## Finitura / Finishing

CR NL OG OL OS	86,00
FINITURE SPECIALI * SPECIAL FINISHING	113,00
GO RG	141,00

## Art. 1486 IN

Portasalvietta cm. 60

Towel holder cm. 60  
 Porte serviette cm. 60  
 Handtuchhalter cm. 60

Toallero cm. 60  
 Toalheiro cm. 60  
 Держатель полотенца 60 см

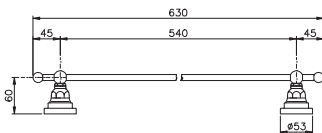

## Finitura / Finishing

CR NL OG OL OS	117,00
FINITURE SPECIALI * SPECIAL FINISHING	163,00
GO RG	212,00

## Art. 1487 IN

Portasapone

Soap holder  
 Porte savon  
 Seifenschale

Jabonera  
 Saboneteira  
 Мыльница

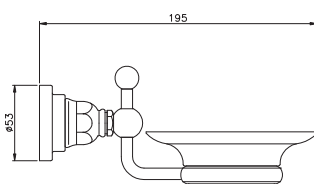

## Finitura / Finishing

CR NL OG OL OS	81,00
FINITURE SPECIALI * SPECIAL FINISHING	106,00
GO RG	137,00

## ACCESSORI BAGNO agorà

## Art. 1488 IN

Portabicchiere

Tumbler holder  
Porte verre  
Becherhalter

Portavaso  
Porta-copos  
Стакан

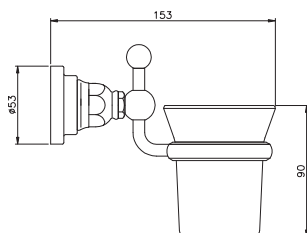

Finitura / Finishing

CR NL OG OL OS 82,00

FINITURE SPECIALI \*  
SPECIAL FINISHING 111,00

GO RG 143,00

## Art. 1489 IN

Dosasapone

Soap dispenser holder  
Porte distributeur de savon  
Selpenspenderhalter

Dispensador de jabón  
Doseador sabão  
Дозатор для жидкого мыла

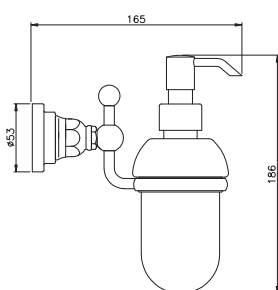

Finitura / Finishing

CR NL OG OL OS 121,00

FINITURE SPECIALI \*  
SPECIAL FINISHING 165,00

GO RG 214,00

## Art. 1490 IN

Portascopino a parete

Wall toilet brush holder  
Porte balai à mur  
Wahdüslengarnitur

Escobillero de pared  
Porta-piçaba parede  
Туалетный ёршик настенный

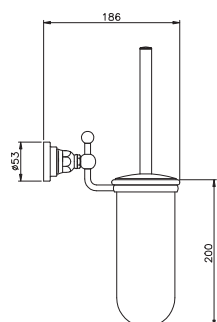

Finitura / Finishing

CR NL OG OL OS 124,00

FINITURE SPECIALI \*  
SPECIAL FINISHING 160,00

GO RG 208,00

## Art. 1492 IN

Portarotolo

Paper holder  
Porte rouleau  
Papierrolenhalter

Portarollo  
Porta-rolos  
Бумагодержатель

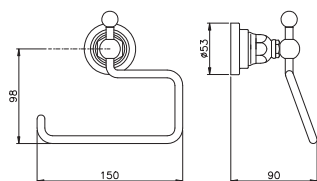

Finitura / Finishing

CR NL OG OL OS 81,00

FINITURE SPECIALI \*  
SPECIAL FINISHING 114,00

GO RG 148,00

## Art. 1493 IN

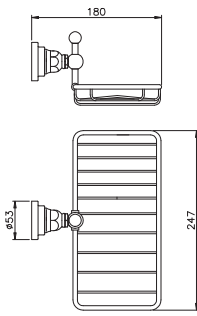
*Portasapone doppio*

Double soap holder  
Porte savon double  
Doppelseenschale

Jabonera doble en rejilla  
Saboneteira rede  
Бумагодержатель двойной

## Finitura / Finishing

CR NL OG OL OS	98,00
FINITURE SPECIALI * SPECIAL FINISHING	128,00
GO RG	166,00

## Art. 1494 IN

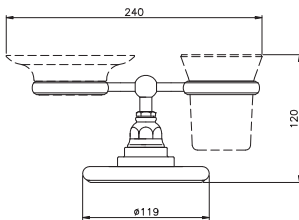
*Portasapone e bicchiere d'appoggio (senza vetri)*

Soap holder with tumbler holder (without glass)  
Porte savon avec porte verre (sans vitrage)  
Saifenschale mit becherhalter (ohne glas)

Jaboneira y portavasos de encimera (sin vidrio)  
Saboneteira e copo dos dentes (sem vidro)  
Держатель мыльницы и стакана настольный (без стекло)

## Finitura / Finishing

CR NL OG OL OS	106,00
FINITURE SPECIALI * SPECIAL FINISHING	146,00
GO RG	189,00

SOLO PER PORTASAPONE E BICCHIERE  
ONLY FOR SOAP DISH AND TUMBLER

## Art. 1495 IN

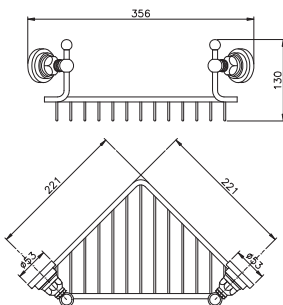
*Portasapone doppio ad angolo*

Double soap holder  
Porte savon double  
Doppelseenschale

Jabonera doble en rejilla  
Saboneteira rede  
Бумагодержатель двойной

## Finitura / Finishing

CR NL OG OL OS	227,00
FINITURE SPECIALI * SPECIAL FINISHING	297,00
GO RG	385,00

## Art. 1497 IN

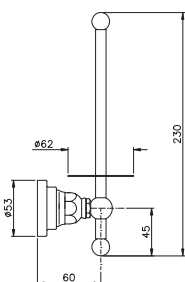
*Portarotolo verticale*

Spare paper holder  
Porte rouleau vertical  
Senkrechten Papierhalter

Portarrollo verticales  
Porta-rolos verticais  
Бумагодержатель вертикальный

## Finitura / Finishing

CR NL OG OL OS	89,00
FINITURE SPECIALI * SPECIAL FINISHING	124,00
GO RG	161,00

## ACCESSORI BAGNO agorà

## Art. 1498 IN

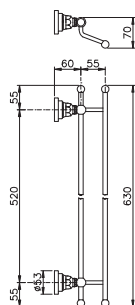
*Portasalvietta doppio*

Double towel holder  
 Porte serviette double  
 Doppel Handtuchhalter

Toallero doble  
 Toalheiro dobro  
 Держатель полотенца двойной

**Finitura / Finishing**

CR NL OG OL OS	159,00
FINITURE SPECIALI * SPECIAL FINISHING	211,00
GO RG	274,00

## Art. 1499 IN

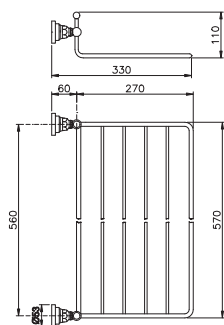
*Griglia portasalviette*

Towels rack  
 Grille porte serviette  
 Gitter Handtuchhalter

En rejilla toallero  
 Rede toallero  
 Держатель полотенца полочка

**Finitura / Finishing**

CR NL OG OL OS	266,00
FINITURE SPECIALI * SPECIAL FINISHING	372,00
GO RG	484,00

# accessori bagno

## ■ MONTE CROCE



*Nicolazzi*



# accessori bagno Monte Croce



**1481** *Appendiabiti*  
Clothes-hanger



**1483** *Portasalvietta cm. 30*  
Towel holder cm. 30



**1487** *Portasapone*  
Soap holder



**1492** *Portarotolo*  
Paper holder

**1484** *Portasalvietta cm. 45*  
Towel holder cm. 45

**1486** *Portasalvietta cm. 60*  
Towel holder cm. 60



**1497** *Portarotolo verticale*  
Spare paper holder

## Art. 1480

Mensola cm. 60

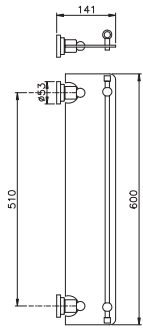

Shelf cm. 60  
Étagère cm. 60  
Ablage cm. 60

Repisa cm. 60  
Prateleira cm. 60  
Полочка 60 см

Finitura / Finishing

27

CR NL OG OL OS 165,00

FINITURE SPECIALI \*  
SPECIAL FINISHING 225,00

GO RG 292,00

## Art. 1481

Appendiabiti

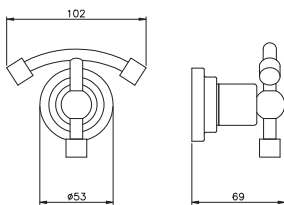

Clothes-hanger  
Vêtements-cintre  
Kleidung-Aufhänger

Percha  
Cabide  
Крючок

Finitura / Finishing

27

CR NL OG OL OS 75,00

FINITURE SPECIALI \*  
SPECIAL FINISHING 102,00

GO RG 133,00

## Art. 1482

Portasalvietta a snodo

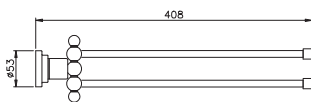

Jointed towel holder  
Porte serviette réglable  
Handtuchhalter

Toallero articulare  
Toalheiro articulado  
Держатель полотенец полочка

Finitura / Finishing

27

CR NL OG OL OS 116,00

FINITURE SPECIALI \*  
SPECIAL FINISHING 154,00

GO RG 199,00

## Art. 1483

Portasalvietta cm.30

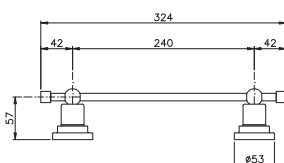

Towel holder cm. 30  
Porte serviette cm. 30  
Handtuchhalter cm. 30

Toallero cm. 30  
Toalheiro cm. 30  
Держатель полотенца 30 см

Finitura / Finishing

27

CR NL OG OL OS 108,00

FINITURE SPECIALI \*  
SPECIAL FINISHING 155,00

GO RG 201,00

## ACCESSORI BAGNO monte croce

## Art. 1484

Portasalvietta cm. 45

Towel holder cm. 45  
 Porte serviette cm. 45  
 Handtuchhalter cm. 45

Toallero cm. 45  
 Toalheiro cm. 45  
 Держатель полотенца 45 см

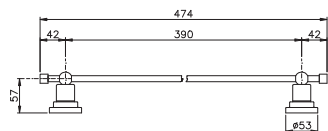

## Finitura / Finishing

27

CR NL OG OL OS 117,00

FINITURE SPECIALI \*  
SPECIAL FINISHING 163,00

GO RG 212,00

## Art. 1485

Portasalvietta ad anello

Towel ring  
 Anneau porte serviette  
 Handtuchring

Toallero de anilla  
 Toalheiro argola  
 Держатель полотенца кольцо

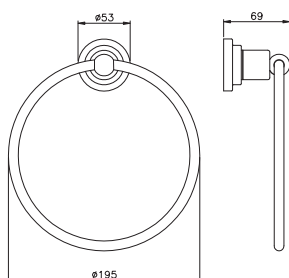

## Finitura / Finishing

27

CR NL OG OL OS 86,00

FINITURE SPECIALI \*  
SPECIAL FINISHING 113,00

GO RG 141,00

## Art. 1486

Portasalvietta cm. 60

Towel holder cm. 60  
 Porte serviette cm. 60  
 Handtuchhalter cm. 60

Toallero cm. 60  
 Toalheiro cm. 60  
 Держатель полотенца 60 см

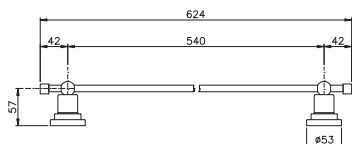

## Finitura / Finishing

27

CR NL OG OL OS 117,00

FINITURE SPECIALI \*  
SPECIAL FINISHING 163,00

GO RG 212,00

## Art. 1487

Portasapone

Soap holder  
 Porte savon  
 Seifenschale

Jabonera  
 Saboneteira  
 Мыльница

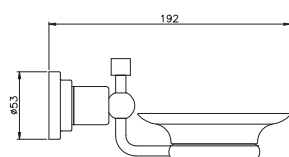

## Finitura / Finishing

27

CR NL OG OL OS 81,00

FINITURE SPECIALI \*  
SPECIAL FINISHING 106,00

GO RG 137,00

## Art. 1488

Portabicchiere

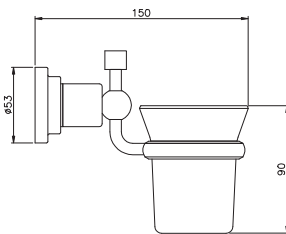
Tumbler holder  
Porte verre  
BecherhalterPortavaso  
Porta-copos  
Стакан

Finitura / Finishing

27

CR NL OG OL OS 82,00

FINITURE SPECIALI \*  
SPECIAL FINISHING 111,00

GO RG 143,00

## Art. 1489

Dosasapone

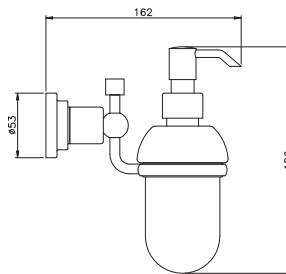
Soap dispenser holder  
Porte distributeur de savon  
SefenspenderhalterDispensador de jabón  
Doseador sabão  
Дозатор для жидкого мыла

Finitura / Finishing

27

CR NL OG OL OS 121,00

FINITURE SPECIALI \*  
SPECIAL FINISHING 165,00

GO RG 214,00

## Art. 1490

Portascopino a parete

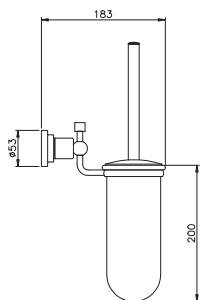
Wall toilet brush holder  
Porte balai à mur  
WahdürslengarniturEscobillero de pared  
Porta-piçaba parede  
Туалетный ёршик настенный

Finitura / Finishing

27

CR NL OG OL OS 124,00

FINITURE SPECIALI \*  
SPECIAL FINISHING 160,00

GO RG 208,00

## Art. 1492

Portarotolo

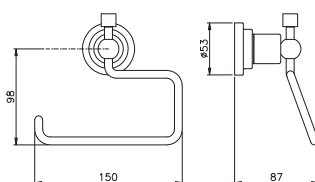
Paper holder  
Porte rouleau  
PapierrolenhalterPortarollo  
Porta-rolos  
Бумагодержатель

Finitura / Finishing

27

CR NL OG OL OS 81,00

FINITURE SPECIALI \*  
SPECIAL FINISHING 114,00

GO RG 148,00

## ACCESSORI BAGNO monte croce

## Art. 1493

Portasapone doppio

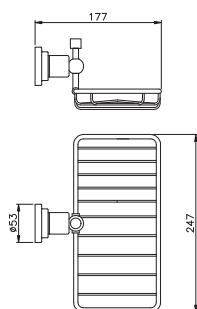

Double soap holder  
Porte savon double  
Doppelselenschale

Jabonera doble en rejilla  
Saboneteira rede  
Бумагодержатель двойной

Finitura / Finishing

27

CR NL OG OL OS 98,00

FINITURE SPECIALI \*  
SPECIAL FINISHING 128,00

GO RG 166,00

## Art. 1494

Portasapone e bicchiere d'appoggio (senza vetri)

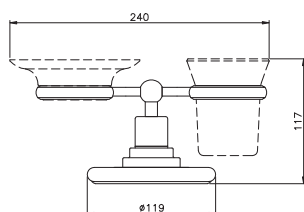

SOLO PER PORTASAPONE E BICCHIERE  
ONLY FOR SOAP DISH AND TUMBLER

Soap holder with tumbler holder (without glass)  
Porte savon avec porte verre (sans vitrage)  
Saifenschale mit becherhalter (ohne glas)

Jaboneira y portavaso de encimera (sin vidrio)  
Saboneteira e copo dos dentes (sem vidro)  
Держатель мыльницы и стакана настольный (без стекло)

Finitura / Finishing

27

CR NL OG OL OS 106,00

FINITURE SPECIALI \*  
SPECIAL FINISHING 146,00

GO RG 189,00

## Art. 1495

Portasapone doppio ad angolo

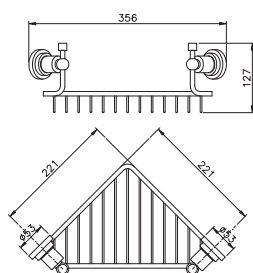

Double soap holder  
Porte savon double  
Doppelselenschale

Jabonera doble en rejilla  
Saboneteira rede  
Бумагодержатель двойной

Finitura / Finishing

27

CR NL OG OL OS 227,00

FINITURE SPECIALI \*  
SPECIAL FINISHING 297,00

GO RG 385,00

## Art. 1497

Portarotolo verticale

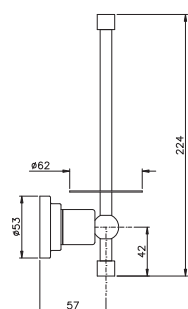

Spare paper holder  
Porte rouleau vertical  
Senkrechten Papierhalter

Portarrollo verticales  
Porta-rolos verticais  
Бумагодержатель вертикальный

Finitura / Finishing

27

CR NL OG OL OS 89,00

FINITURE SPECIALI \*  
SPECIAL FINISHING 124,00

GO RG 161,00

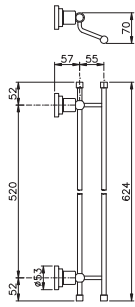
**Art. 1498***Portasalvietta doppio*

Double towel holder  
Porte serviette double  
Doppel Handtuchhalter

Toallero doble  
Toalheiro dobro  
Держатель полотенца двойной

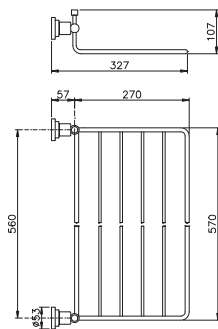
**Finitura / Finishing****27**CR NL OG OL OS **159,00**FINITURE SPECIALI \*  
SPECIAL FINISHING **211,00**GO RG **274,00****Art. 1499***Griglia portasalviette*

Towels rack  
Grille porte serviette  
Gitter Handtuchhalter

En rejilla toallero  
Rede toallero  
Держатель полотенца полочка

**Finitura / Finishing****27**CR NL OG OL OS **266,00**FINITURE SPECIALI \*  
SPECIAL FINISHING **372,00**GO RG **484,00**



# articoli vari - complementi



**5528** *Termoarredo ad Acqua*  
Water towel heater



**5528 E** *Termoarredo elettrico*  
Electric towel heater



**LIBERTY**  
**5542--16** *Piastra Geberit\**  
Flush plate



**5542** *Piastra Geberit\**  
Flush plate



**IMPERO**  
**3406** *Parte esterna monocomando doccia incasso*  
Ext. part of single-lever for built-in shower



**IMPERO**  
**3460** *Parte esterna monoc. doccia incasso con deviatore*  
Ext. part of single-lever for built-in shower with diverter



**3478** *Monocomando lavabo a incasso*  
Single Lever wall mounted basin mixer



**OLYMPUS**  
**3778** *Monocomando lavabo a incasso*  
Single Lever wall mounted basin mixer

# articoli vari - complementi



*Nicolazzi*

## ARTICOLI VARI - COMPLEMENTI

## Art. 5528

Termoarredo ad Acqua

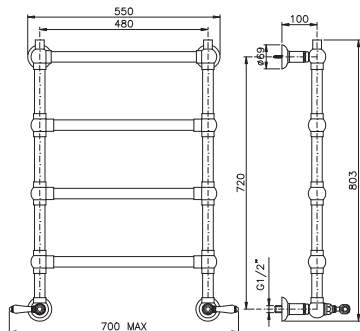
Water towel heater  
Chauffe-serviettes à eau  
Wasser HandtuchwärmerCalentador de toallas agua  
Aquecedor de toalhas água  
Полотенцесушители водяной

Finitura / Finishing							
	<b>18 70 69</b>						
	<b>07 01 60</b>	<b>78 62 30</b>	<b>79 31</b>	<b>05 44</b>	<b>78A 78B</b>	<b>93 34 32</b>	<b>43</b>
	<b>27 29</b>						
CR NL OG OL OS	1.300,00	1.312,00	1.320,00	1.336,00	1.360,00	1.408,00	1.436,00
FINITURE SPECIALI * SPECIAL FINISHING	1.820,00	1.837,00	1.848,00	1.871,00	1.904,00	1.972,00	2.011,00
GO RG	2.600,00	2.624,00	2.640,00	2.672,00	2.720,00	2.816,00	2.872,00

Finitura / Finishing					
	<b>39 39W</b>			<b>09 090</b>	
	<b>17 15 45</b>	<b>36 36L</b>	<b>16</b>	<b>09C</b>	<b>15C</b>
CR NL OG OL OS	1.480,00	1.566,00	1.723,00	2.760,00	2.914,00
FINITURE SPECIALI * SPECIAL FINISHING	2.072,00	2.193,00	2.413,00	3.864,00	4.080,00
GO RG	2.960,00	3.132,00	3.446,00	5.520,00	5.828,00

Alcuni esempi di maniglie / Some handles example



Art. **5528 E**

Termoarredo elettrico

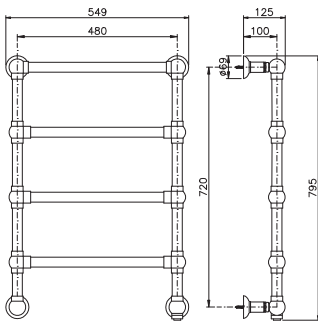

Electric towel heater  
 Chauffe-serviettes électrique  
 Elektrische Handtuchheizung

Calentador de toallas eléctrico  
 Aquecedor eléctrico de toalha  
 Электрический нагреватель Полотенце

## Finitura / Finishing

CR NL OG OL OS 1.500,00

FINITURE SPECIALI \*  
SPECIAL FINISHING 2.020,00

GO RG 2.800,00

## SU RICHIESTA - ON DEMAND

Questo articolo è disponibile anche con maniglie decorative.

This article is also available with decorative handles.

## ATTENZIONE - CAUTION

\*\* Sono disponibili per questo articolo differenti attacchi e voltaggi.

Si prega di indicare il paese di destinazione/installazione del prodotto sull'ordine per potervi fornire il prodotto idoneo.

\*\* Are available for this article different attacks and voltages.

Please indicate the country of destination/installation over your order to be able to provide suitable product.

Art. **5542--16**

Piastra scarico sistemi Geberit\*

Flush plate  
 Plaque de vidage  
 Betätigungsplatte

Placa de descarga  
 Placa de descargas  
 вытяжная пластина

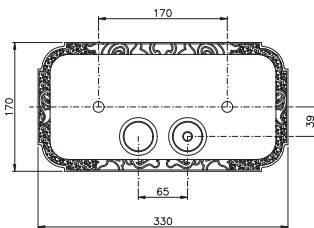

## Finitura / Finishing

LIBERTY

**16**

CR NL OG OL OS 499,00

FINITURE SPECIALI \*  
SPECIAL FINISHING 670,00

GO RG 980,00

## ATTENZIONE - CAUTION

\*\* Questo articolo è compatibile con i modelli UNICA, KOMBIFIX, UP300 e UP 320 di GEBERIT.

\*\* This item is suitable for Geberit models UNICA, KOMBIFIX, UP300, UP320.

\* Geberit is a register trademark GEBERIT AG

Art. **5542**

Piastra scarico sistemi Geberit\*

Flush plate  
 Plaque de vidage  
 Betätigungsplatte

Placa de descarga  
 Placa de descargas  
 вытяжная пластина

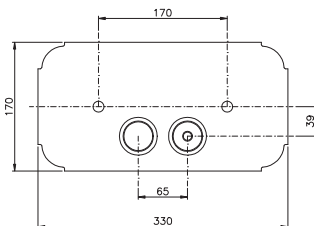

## Finitura / Finishing

CR NL OG OL OS 360,00

FINITURE SPECIALI \*  
SPECIAL FINISHING 471,00

GO RG 720,00

## ATTENZIONE - CAUTION

\*\* Questo articolo è compatibile con i modelli UNICA, KOMBIFIX, UP300 e UP 320 di GEBERIT.

\*\* This item is suitable for Geberit models UNICA, KOMBIFIX, UP300, UP320.

\* Geberit is a register trademark GEBERIT AG

## ARTICOLI VARI - COMPLEMENTI

## Art. 4006

*Corpo monocomando doccia incasso*

Single-lever body for built-in shower  
Corps mono-commande douche à encaiss  
Einhandteil f. eingeb. Dusche

Parte int. monomando ducha empotrado  
Corpo monocomando ducha encastrado  
Встраиваемая часть встраиваемого для душа

Finitura / Finishing

58,00

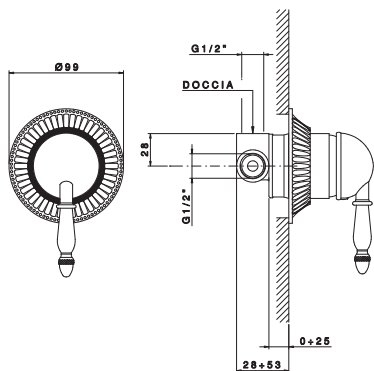

## Impero Art. 3406

*Parte esterna monocomando doccia incasso*

Ext. part of single-lever for built-in shower  
Partie ext. mono-commande de douche encaiss  
Aussett. des Einhandm. f. eingeb. Dusche

Parte ext. monomando ducha empotrado  
Parte ext. monocomando ducha encastrado  
Наружная часть встраиваемого смес. для душа

Finitura / Finishing

**36LM**

CR NL OG OL OS 159,00

FINITURE SPECIALI \*  
SPECIAL FINISHING 223,00

GO RG 337,00

## Art. 4060

*Corpo monocomando doccia incasso con deviatore*

Single-lever body for built-in shower with diverter  
Corps mono-commande douche à encaiss avec aiguillage  
Einhandteil f. eingeb. Dusche mit Ablenker

Parte int. monomando ducha empotrado  
Corpo monocomando ducha encastrado com desviador  
Встраиваемая часть встр. для душа с переключателем

Finitura / Finishing

89,00

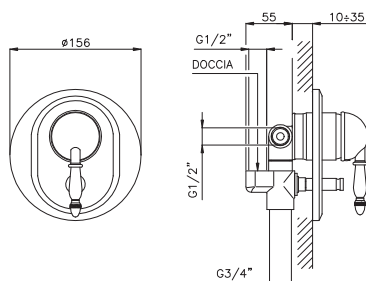

## Impero Art. 3460

*Parte esterna monoc. doccia incasso con deviatore*

Ext. part of single-lever for built-in shower with diverter  
Partie ext. douche à encaiss avec aiguillage  
Einhandteil f. eingeb. Dusche mit Ablenker

Parte ext. monomando ducha empotrado con desviador  
Corpo monocomando ducha encastrado com desviador  
Наружная часть встр. для душа с переключателем

Finitura / Finishing

**36LM**

CR NL OG OL OS 172,00

FINITURE SPECIALI \*  
SPECIAL FINISHING 242,00

GO RG 357,00

**Impero Art. 1232***Monoforo lavabo scarico automatico*

Basin single-hole mixer with automatic pop-up waste  
 Mélangeur lavabo monotrou avec vidage automatique  
 Einloch-Waschbecken mit automatischem Ablauf

Monohuero lavabo con desagüe automático  
 Monofuro lavatorio c/v.d.a.  
 Двухвентильный с автоматическим сливом для раковины

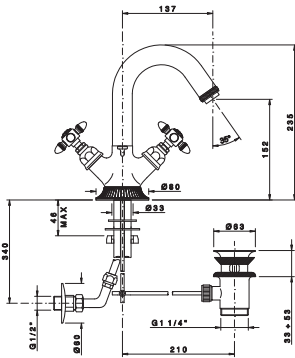

Finitura / Finishing

**36**

CR NL OG OL OS 618,00

FINITURE SPECIALI \*  
SPECIAL FINISHING 835,00

GO RG 979,00

**Impero Art. 1234***Monoforo bidet scarico automatico*

Bidet single-hole mixer with automatic pop-up waste  
 Mélangeur bidet monotrou avec vidage automatique  
 Einloch-Bidet mit automatischem Ablauf

Monohuero lbide con desagüe automático  
 Monofuro bidet c/v.d.a.  
 Двухвентильный с автоматическим сливом для биде

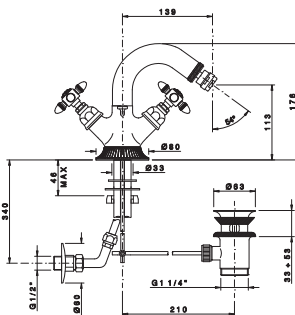

Finitura / Finishing

**36**

CR NL OG OL OS 618,00

FINITURE SPECIALI \*  
SPECIAL FINISHING 835,00

GO RG 979,00

**Impero Art. C8075***Saliscendi*

Wall sliding rail  
 Rampe murale  
 Wandstage

Barra deslizante  
 Rampa  
 Штанга

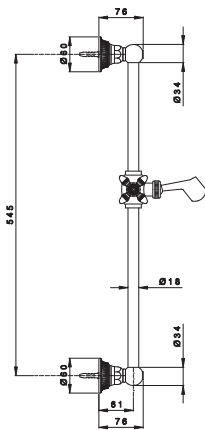

Finitura / Finishing

**36**

CR NL OG OL OS 360,00

FINITURE SPECIALI \*  
SPECIAL FINISHING 504,00

GO RG 684,00

**Art. C8072***Saliscendi*

Wall sliding rail  
 Rampe murale  
 Wandstage

Barra deslizante  
 Rampa  
 Штанга

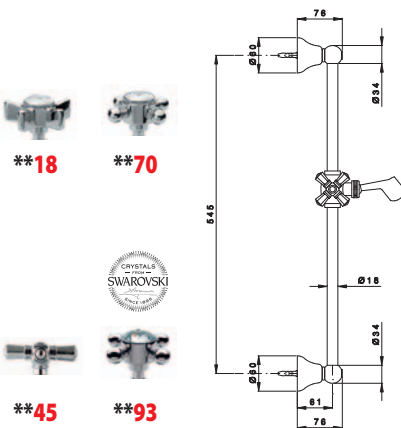

Finitura / Finishing

**18****70****45****93**

CR NL OG OL OS 200,00 200,00 260,00 250,00

FINITURE SPECIALI \*  
SPECIAL FINISHING 280,00 280,00 364,00 350,00

GO RG 380,00 380,00 494,00 475,00



ARTICOLI VARI - COMPLEMENTI

Art. 4006

Corpo monocomando doccia incasso

Single-lever body for built-in shower  
Corps mono-commande douche à encaiss  
Einhandteil f. eingeb. Dusche

Parte int. monomando ducha empotrado  
Corpo monocomando ducha encastrado  
Встраиваемая часть встраиваемого для душа

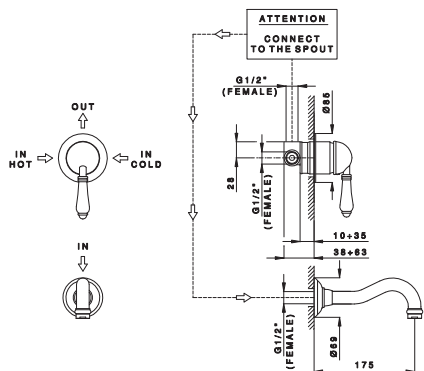

Finitura / Finishing

58,00

Art. 3478

Monocomando lavabo incasso

Single-lever wall mounted basin mixer  
Mélangeur lavabo encaiss  
Waschtisch eingelassen

Monomando lavabo empotrado  
Monomando de lavatorio encastrado  
однорычажный для умывальника встраиваемые

INSTALLATION EXAMPLES

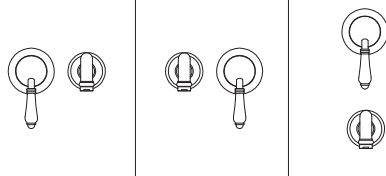

Finitura / Finishing

	CRISTALLO	LIBERTY BLACK	DECORATED CERAMICS	EL CAPITAN	P.M. BLANC	P.M. BLANC A	CERAMICA NERA	FOREST
	<b>33</b>	<b>40</b>	<b>46</b>	<b>75</b>	<b>76</b>	<b>76A</b>	<b>76B</b>	<b>77</b>
CR NL OG OL OS	238,00	256,00	313,00	216,00	220,00	233,00	233,00	233,00
FINITURE SPECIALI * SPECIAL FINISHING	334,00	360,00	440,00	303,00	309,00	327,00	327,00	327,00
GO RG	476,00	512,00	626,00	432,00	440,00	466,00	466,00	466,00

\*\*33 Cristallo

\*\*40 Liberty Black

\*\*46 Decorated ceramics

\*\*75 El Capitan

\*\*76 P. Mont Blanc

\*\*76A P. Mont Blanc  
Ceramica anticata  
Antique ceramic

\*\*76B Ceramica nera

\*\*77 Forest



Olympus Art. 3778

Monocomando lavabo incasso

Single-lever wall mounted basin mixer  
Mélangeur lavabo encaiss  
Waschtisch eingelassen

Monomando lavabo empotrado  
Monomando de lavatorio encastrado  
однорычажный для умывальника встраиваемые

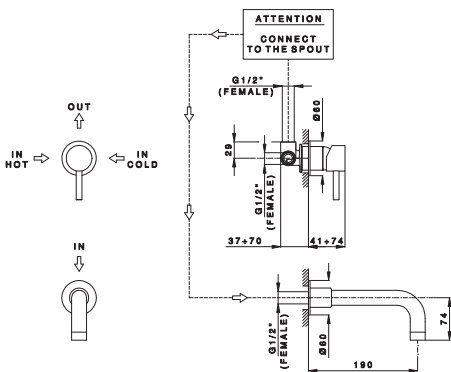

INSTALLATION EXAMPLES

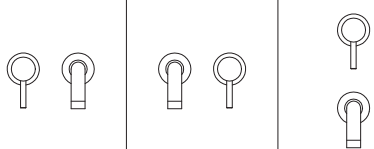

Finitura / Finishing

CR NL OG OL OS	255,00
FINITURE SPECIALI * SPECIAL FINISHING	385,00
GO RG	460,00

## ARTICOLI VARI - COMPLEMENTI

## Art. 5573

Coppia attacchi verticali per vasca esterna

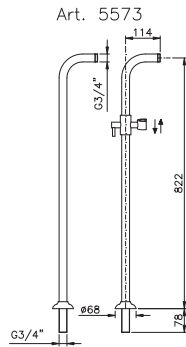

Couple of fixed vertical connection for external bathtub  
Couple jonctions verticales pour mélang. bain  
Paar bindung für äußere badewannengruppe

Par conexiones verticales para bañera  
Par de ataduras verticais para banheira exterior  
Пара вертикальных крепежей для ванны

## Finitura / Finishing

CR NL OG OL OS	444,00
FINITURE SPECIALI * SPECIAL FINISHING	639,00
GO RG	818,00

## Art. 1496B

Portasalviette

Towel holder  
Porte serviette  
Handtuchhalter

Toallero  
Toalheiro  
Держатель полотенца

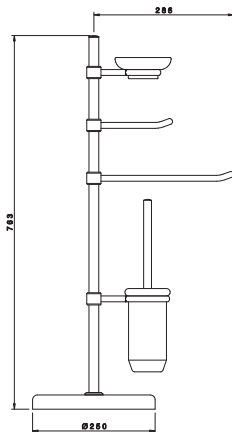

## Finitura / Finishing

CR NL OG OL OS	800,00
FINITURE SPECIALI * SPECIAL FINISHING	1.122,00
GO RG	1.426,00

## Art. 1496B A

Ceramica anticata

Antique ceramic  
Ceramique vieillie  
Antike keramik

Ceramica antigua  
Ceramica antigua  
Керамика антик

## Finitura / Finishing

CR NL OG OL OS	829,00
FINITURE SPECIALI * SPECIAL FINISHING	1.161,00
GO RG	1.476,00

## Art. 1496B B

Ceramica nera

Black ceramic  
Ceramique noir  
Schwarzes keramik

Ceramica negra  
Ceramica preto  
Керамика черная

## Finitura / Finishing

CR NL OG OL OS	879,00
FINITURE SPECIALI * SPECIAL FINISHING	1.231,00
GO RG	1.565,00

## Art. 1496B D

Ceramica decorata

Decorated ceramic  
Décorée en Ceramique  
Keramik verziert

Decoración ceramica  
Decoração ceramica  
Керамика украшенные

## Finitura / Finishing

CR NL OG OL OS	1.058,00
FINITURE SPECIALI * SPECIAL FINISHING	1.482,00
GO RG	1.884,00

## Art. 1496L

Portasalviette

Towel holder  
Porte serviette  
Handtuchhalter

Toallero  
Toalheiro  
Держатель полотенца

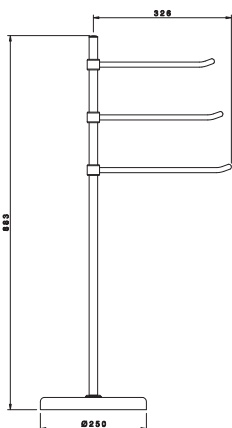

## Finitura / Finishing

CR NL OG OL OS	730,00
FINITURE SPECIALI * SPECIAL FINISHING	1.022,00
GO RG	1.300,00

## MANIGLIE E LEVE

## LIBERTY C7616



Finitura / Finishing

CR NL OG OL OS 150,00

FINITURE SPECIALI \*  
SPECIAL FINISHING 195,00

GO RG 290,00

## ARENA C7644



Finitura / Finishing

CR NL OG OL OS 43,00

FINITURE SPECIALI \*  
SPECIAL FINISHING 56,00

GO RG 77,00

## AGORA' C7645IN



Finitura / Finishing

CR NL OG OL OS 93,00

FINITURE SPECIALI \*  
SPECIAL FINISHING 129,00

GO RG 197,00

## AGORA' C7605IN



Finitura / Finishing

CR NL OG OL OS 50,00

FINITURE SPECIALI \*  
SPECIAL FINISHING 67,00

GO RG 94,00

## MANIGLIE E LEVE

## AGORA' C7618IN



Finitura / Finishing

CR NL OG OL OS	32,00
FINITURE SPECIALI * SPECIAL FINISHING	42,00
GO RG	58,00

## TORRE C7657



Finitura / Finishing

CR NL OG OL OS	28,00
FINITURE SPECIALI * SPECIAL FINISHING	42,00
GO RG	58,00

## monocomando ARENA C7648



Finitura / Finishing

CR NL OG OL	28,00
FINITURE SPECIALI * SPECIAL FINISHING	42,00
GO	58,00

## monocomando ARENA C7648MD

Finitura / Finishing

	<b>Art. 4106-4178-4196</b>
CR NL OG OL	28,00
FINITURE SPECIALI * SPECIAL FINISHING	42,00
GO	58,00

## PULL-DOWN 3420 - C7675P



Finitura / Finishing

CR NL OG OL	50,00
FINITURE SPECIALI * SPECIAL FINISHING	70,00
GO	98,00

## MANIGLIE E LEVE - ARTICOLI VARI



**Ceramica Anticata**  
*Antique Ceramic*

PULL-DOWN 3420 - **C7676P**

Finitura / Finishing

CR NL OG OL 57,00

FINITURE SPECIALI \*  
SPECIAL FINISHING 80,00

GO 114,00

PULL-DOWN 3420 - **C7676AP**

**Ceramica anticata** / *Antique ceramic*

Finitura / Finishing

CR NL OG OL 64,00

FINITURE SPECIALI \*  
SPECIAL FINISHING 91,00

GO 128,00

PULL-DOWN 3420 - **C7677P**

Finitura / Finishing

CR NL OG OL 55,00

FINITURE SPECIALI \*  
SPECIAL FINISHING 77,00

GO 109,00

PULL-DOWN 3430 - **C7629P**

Finitura / Finishing

CR NL OG OL 55,00

FINITURE SPECIALI \*  
SPECIAL FINISHING 72,00

GO 105,00

Art. **3009 D 35 P**

*Cartuccia monocomando Arena*

Cartridge for Arena serie  
Cartouche pour série Arena  
Einhebel-Kartusche für Arena

Cartucho monomando serie Arena  
Cartucho ceramico p/monocomando Arena  
Картридж однорычажного Arena

Finitura / Finishing

50,00



# condizioni di vendita

## sales condition

### VALIDITA' DEL CONTRATTO, QUOTAZIONI, CONSEGNA

Con il conferimento dell'ordine si intendono integralmente accettate le seguenti condizioni:

- Gli ordini trasmessi direttamente o tramite rappresentante costituiscono impegno per la ditta NICOLAZZI SpA solo dopo la conferma scritta.
- L'annullamento di un ordine non può essere ottenuto senza il consenso della ditta.
- I termini di consegna si intendono approssimativi e non impegnativi essendo essi vincolati alle disponibilità del momento, la mancata osservanza da parte nostra dei termini di consegna indicati non dà diritto al cliente di annullare l'ordine, differire i pagamenti o reclamare indennizzi, compensi, penali o danni di sorta.
- Salvo diverse intese o ritardi di consegna dovuti a causa di forza maggiore gli ordini cessano di validità 6 mesi dopo la conferma scritta.
- La merce viaggia a rischio e pericolo del destinatario anche quando la spedizione viene effettuata in porto franco, l'azienda declina ogni responsabilità per ritardi, guasti, avarie, rotture, danni, ammanchi causati direttamente o indirettamente dal vettore.
- Le quotazioni di questo catalogo/listino si intendono IVA esclusa e sono espressi in Euro; le quotazioni si intendono per merce resa franco stabilimento di Alzo.
- I prezzi del presente catalogo/listino sono calcolati sugli elementi di costo attuali; nel caso in cui questi dovessero variare saranno modificati in conformità i prezzi.
- La ditta si riserva inoltre il diritto di modificare tecnicamente ed esteticamente la propria produzione.

### RECLAMI

- Eventuali reclami riguardanti la quantità o la qualità della merce consegnata debbono essere fatti entro otto giorni dal ricevimento della merce e sempre che la merce si trovi nelle stesse condizioni.
- I materiali ritenuti difettosi potranno essere restituiti solamente previa visione del ns agente ed autorizzazione della ditta. La spedizione dovrà essere effettuata in porto franco.
- La responsabilità della ditta si limita alla sostituzione dei pezzi difettosi e non indennizza eventuali danni diretti o indiretti causati dai nostri materiali.
- Si declina inoltre ogni responsabilità per errata installazione e/o manomissione dei nostri materiali.

### PAGAMENTI

- Le modalità di pagamento specificate in fattura si intendono tassative: ogni cambiamento che non sia stato preventivamente ed espressamente pattuito non verrà accettato.
- In caso di ritardato pagamento verranno addebitati gli interessi di mora nella misura stabilita dall'art 5 del D.Leg 231/2002 che decorreranno dal giorno successivo alla scadenza.

### RISERVA DI PROPRIETA'

- La merce consegnata rimane di riservato dominio della NICOLAZZI SpA fino all'avvenuto pagamento.

### CONTESTAZIONI

- Per eventuali contestazioni è esclusivamente competente il foro di Verbania.

### GARANZIA

- Tutti i nostri prodotti stati rigorosamente controllati e collaudati prima di essere posti in vendita e sono coperti da garanzia per un periodo di 6 anni dalla data di acquisto del primo acquirente.
- La garanzia decade qualora:
  1. sia fatto un uso improprio del prodotto
  2. il materiale sia stato modificato o manipolato da persona non autorizzata dalla NICOLAZZI SpA
  3. Il materiale sia stato montato in maniera non corretta
  4. il deterioramento della rubinetteria o dei suoi componenti sia dovuto alla qualità dell'acqua (es. calcare)
- Le superfici non sono coperte da garanzia in quanto subordinate alla cura dell'utente.

### VALIDITY OF ORDERS (POS), PRICES, DELIVERY

In reference to your PO we consider accepted following conditions:

- Pos received directly or through agent are an engagement from NICOLAZZI SpA only after written confirmation.
- Pos can be cancelled only in agreement with NICOLAZZI SpA.
- The delivery times are approximate and not binding since they are bound by the availability of the moment. Our failure to observe the terms of delivery specified does not entitle the customer to cancel the order, defer payments or claim any compensation, fees, penalties or damage of any kind.
- If it is not differently indicated orders lose their validity 6 months after confirmation.
- The goods travel at the risk of the recipient when the shipment is prepaid, the company accepts no responsibility for delays, failures, breakdowns, breakages, damage, shortages caused directly or indirectly by the carrier.
- The prices in this catalog / price list are exclusive of VAT and are expressed in Euro; Prices indicated in this documentation are intended Ex work Alzo - EXW.
- Prices in this catalog / price list are calculated on the elements of the current costs; in case these should differ will be amended in accordance with the prices.
- NICOLAZZI SpA has the right to change products in order to improve them technically and aesthetically.

### COMPLAIN

- Claims are accepted within 8 days from receiving the goods.
- Returns are accepted only after control of our Area Managers or agents and Company authorization. Return shipment will be done in DDP terms – Delivery Duty Paid - (Carriage Paid).
- Company will replace defective components without refunding direct and in direct damages caused by our goods.
- NICOLAZZI SpA is not responsible for improper installations or non authorized modifications of its goods.

### PAYMENTS

- The terms of payment specified in the bill are mandatory. Every change that has not been previously and expressly agreed upon will not be accepted.
- In case of delayed payment will be charged default interest in the amount established by Article 5 of the D.Leg 231/2002 which will begin the day after the deadline.

### PROPERTY

- Goods are of NICOLAZZI SpA's property until payment has been settled.

### LEGAL ISSUES

- In case of legal needs it is competent "Foro di Verbania".

### WARRANTY

- All our products have been rigorously checked and tested before being offered for sale and are warranted for a period of 6 years from the date of the first customer purchase.
- The warranty is void if:
  1. has made improper use of the product
  2. the material has been altered or manipulated by an unauthorized person from NICOLAZZI SpA
  3. the material has been assembled incorrectly
  4. the deterioration of the fitting or its components is due to water quality (eg. limestone).
- The surfaces are not covered by warranty as subject to the care and use of the user.

